

Montageanleitung

Notice de montage

Assembly instruction

GERMANIA[®]
the furniture factory

Schiebetürregal 4037

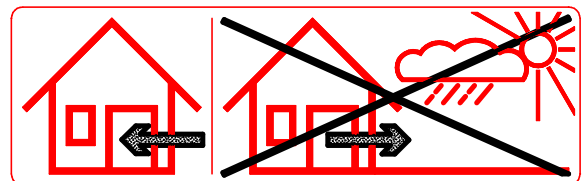
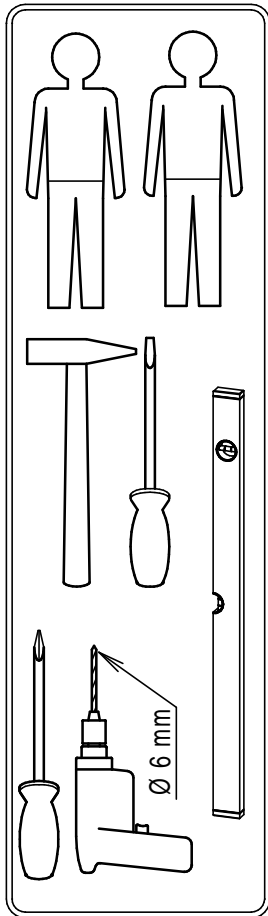
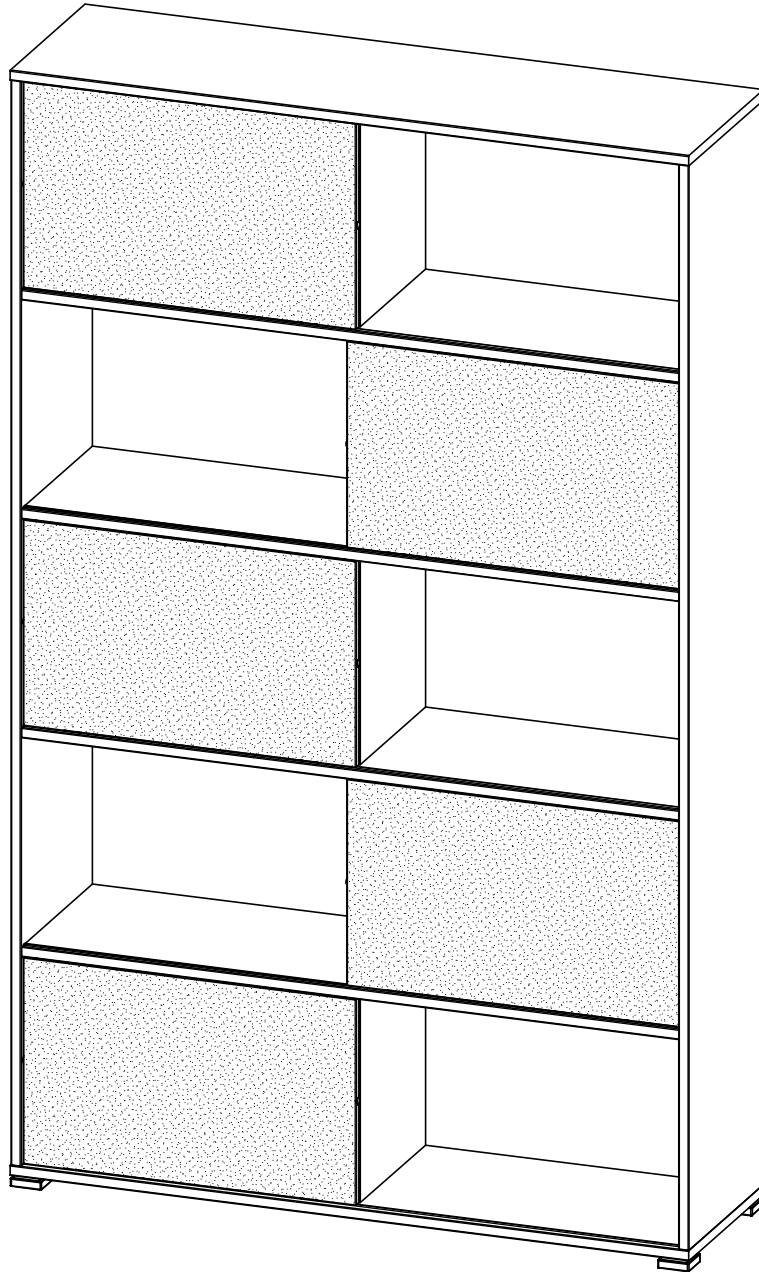



Bitte die Sicherheitshinweise auf der letzten Seite beachten!
Please note: safety instructions on the last page!

Prière de suivre les instructions de sécurité figurant sur la dernière page!

erstellt	geändert	geprüft
Datum: 25.04.2013	Datum:	Datum: 29.04.2013

Mod. 4037 Teileliste - liste de pièces - partlist

2218
44 x

Ø8 x 30mm

1116
24 x

Ø15mm

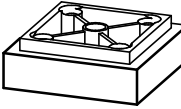
1114
24 x

24 mm

1162
24 x

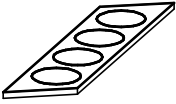
24 mm

5403
4 x

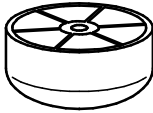
55x55 mm

1071
8 x

Ø4x30mm

4684
3 x

Ø12x1,6 mm

4014
5 x

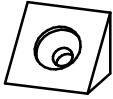
Ø45 mm

1165
5 x

Ø4x22mm

1267
40 x

Ø3x16

4095
4 x

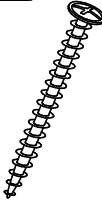
10x10x13mm

1058
4 x

Ø3x15mm

1110
1 x

Ø6x30mm

1021
1 x

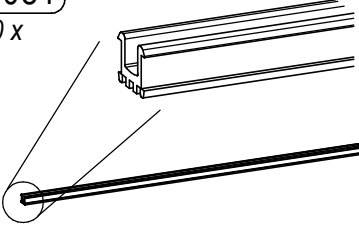
Ø4,5x40mm

1298
2 x

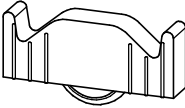
Ø4x15mm

1187
1 x

90x30x15

4081
10 x

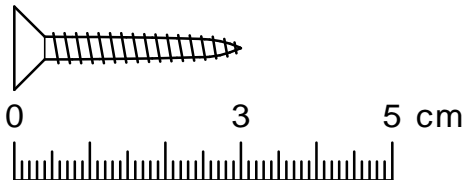
1162 mm

4075
10 x

10 x

4077
10 x

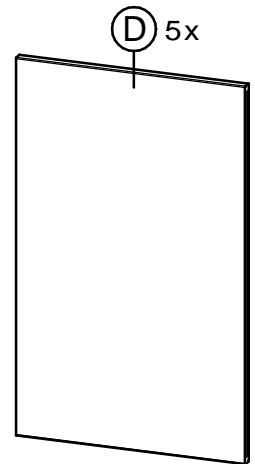
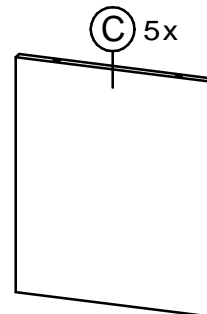
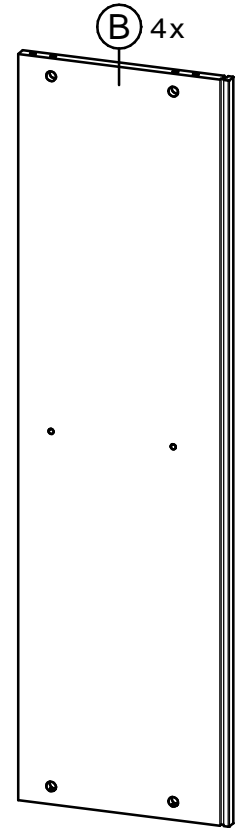
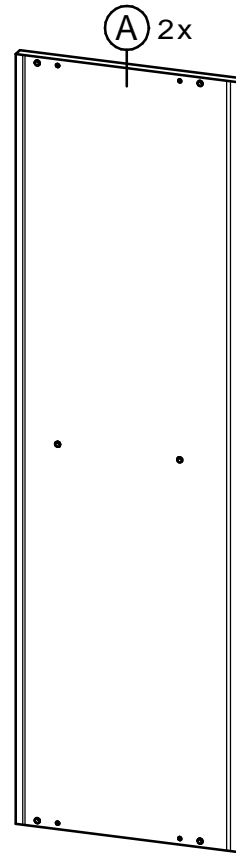
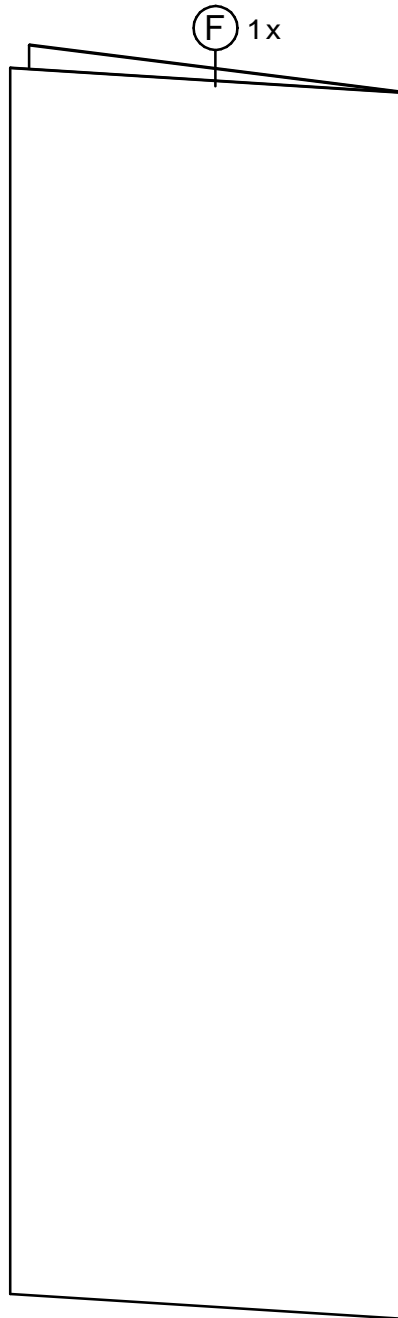
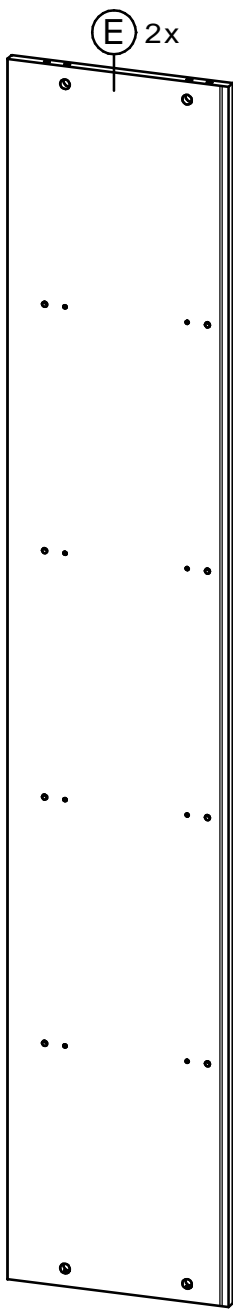
10 x



Mod. 4037 **Teileliste** - liste de pièces - partlist



erstellt	geändert	geprüft
Datum: 25.04.2013	Datum:	Datum: 29.04.2013

Mod. 4037 Montageschritte - ordre de montage - assembly instructions

1. **1 x 1.1**

1071 5465 1165 4014 (A) 1162 mm

4014 5 x Ø45 mm

1165 5 x Ø4x22mm

5403 4x 55x55 mm

1071 8 x Ø4x30mm

4081 2 x 1162 mm

1.2

1114 8 x 24 mm

4081 (A)

1 x 1.3

1114 8 x 24 mm

4081 (A)

19 mm

2. **4 x**

2218 16 x Ø8 x 30mm

1116 16 x Ø15mm

4081 8 x 1162 mm

2218

(B)

3.

2 x

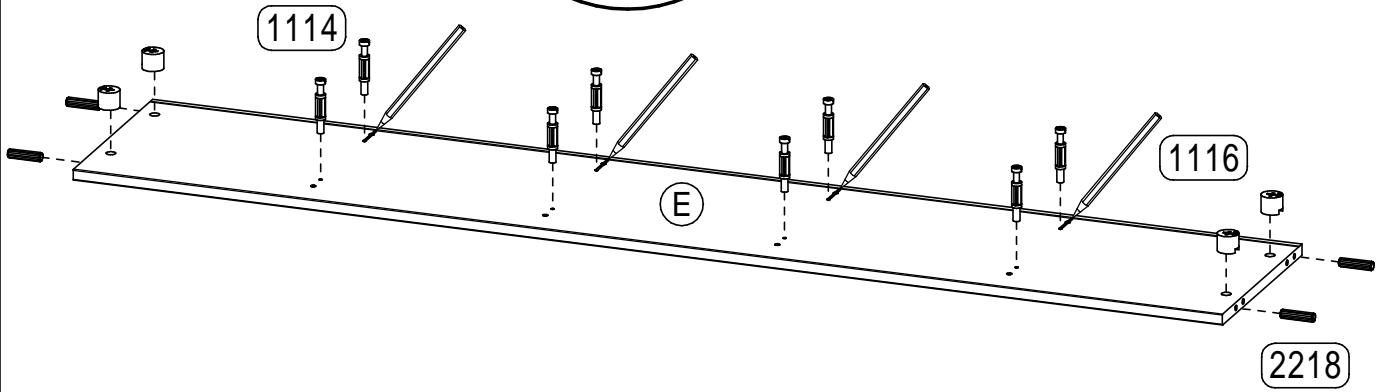
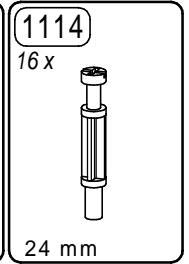
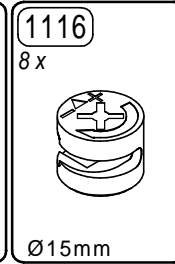
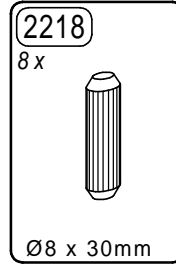
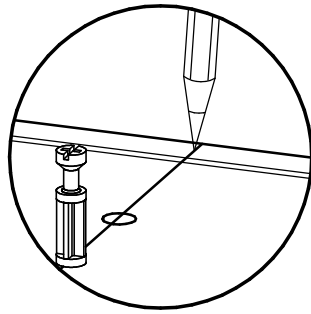

4.

5 x

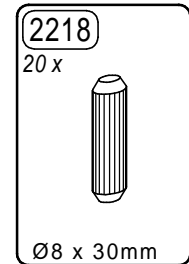
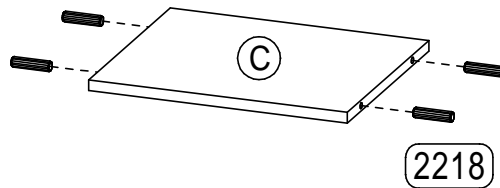

5.

5 x

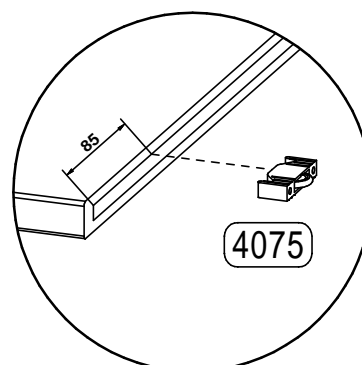
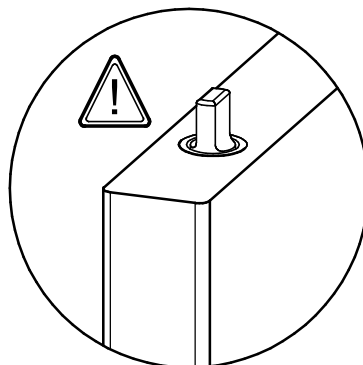
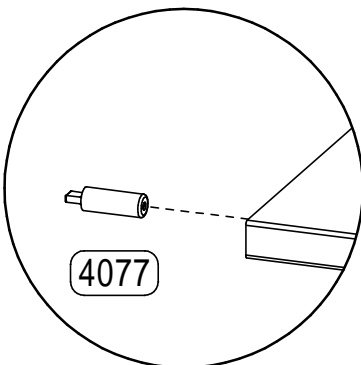
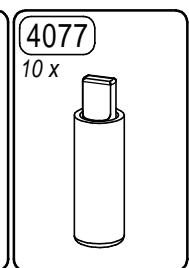
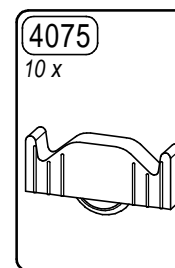
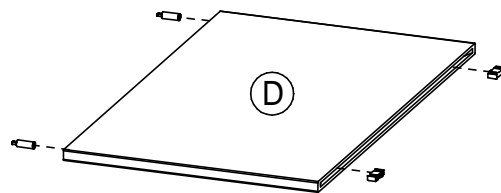

6.

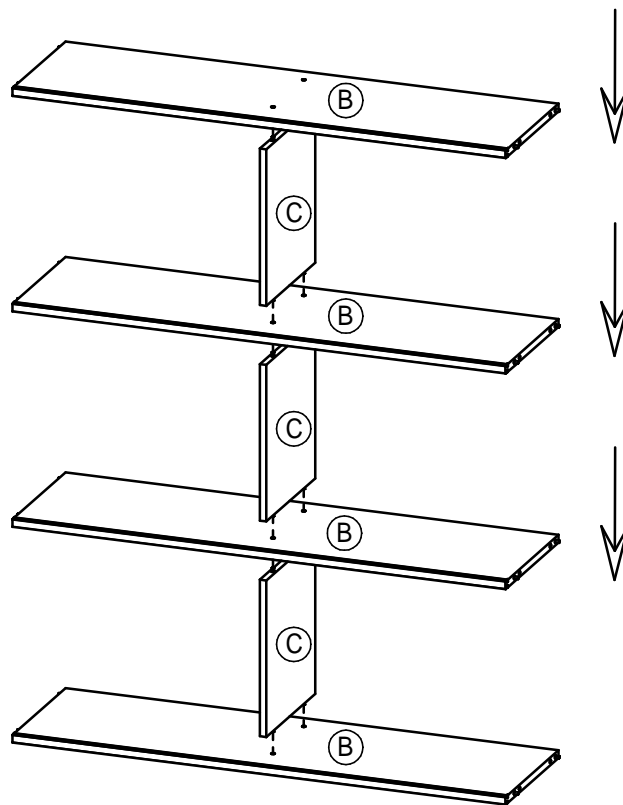
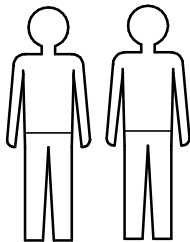

7.

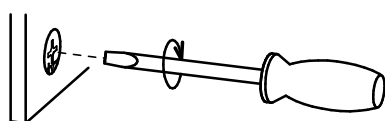
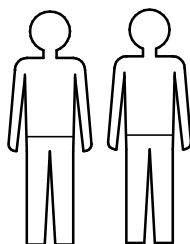

7.2

7.1

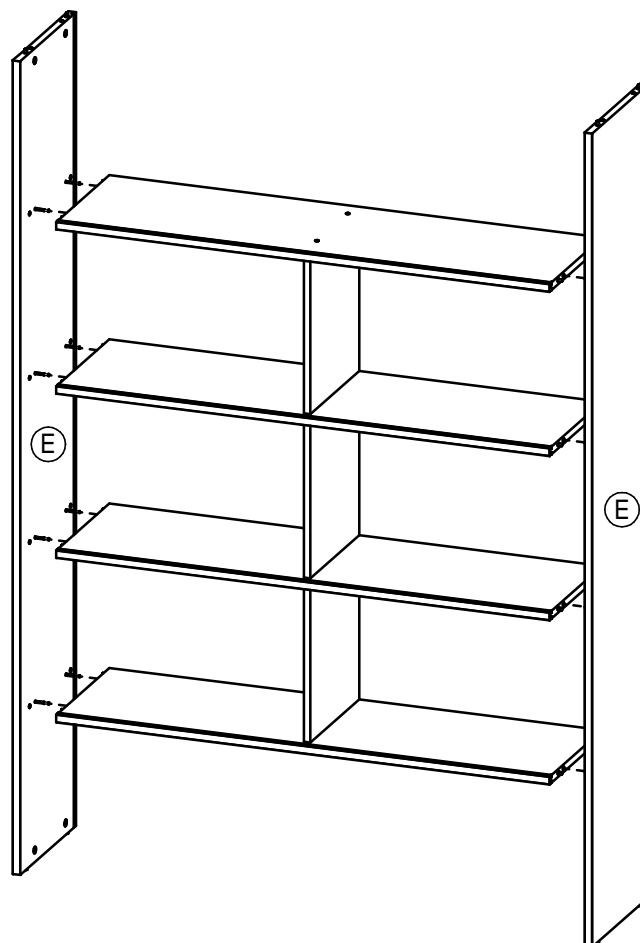
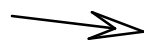

7.1

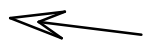

6

erstellt

Datum: 25.04.2013

geändert

Datum:

geprüft

Datum: 29.04.2013

8.

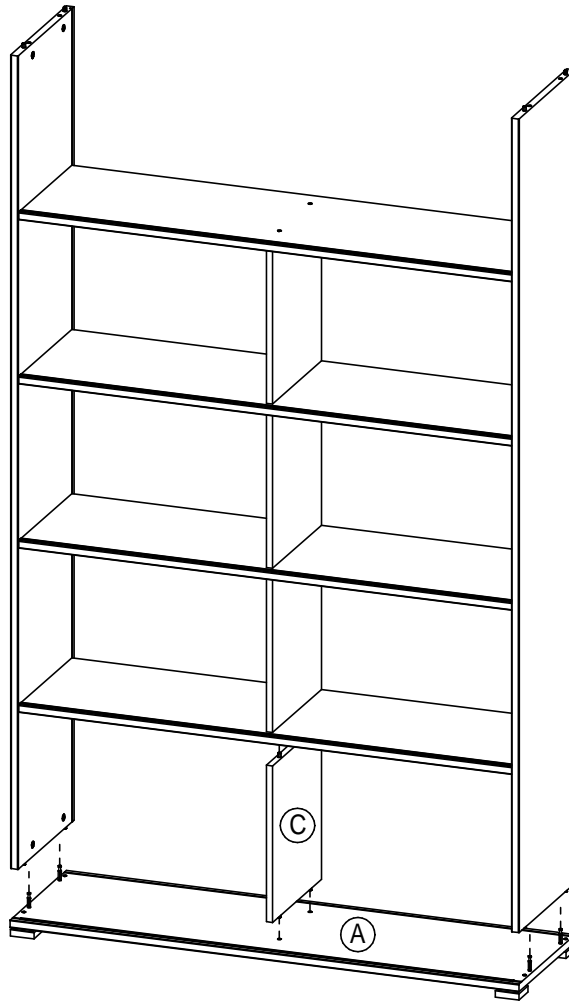
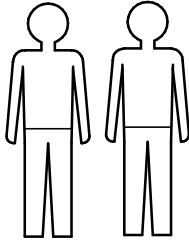

8.1

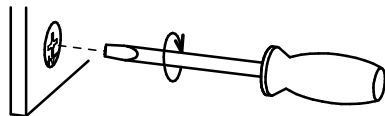

8.2

9.

9.1

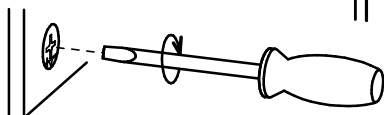
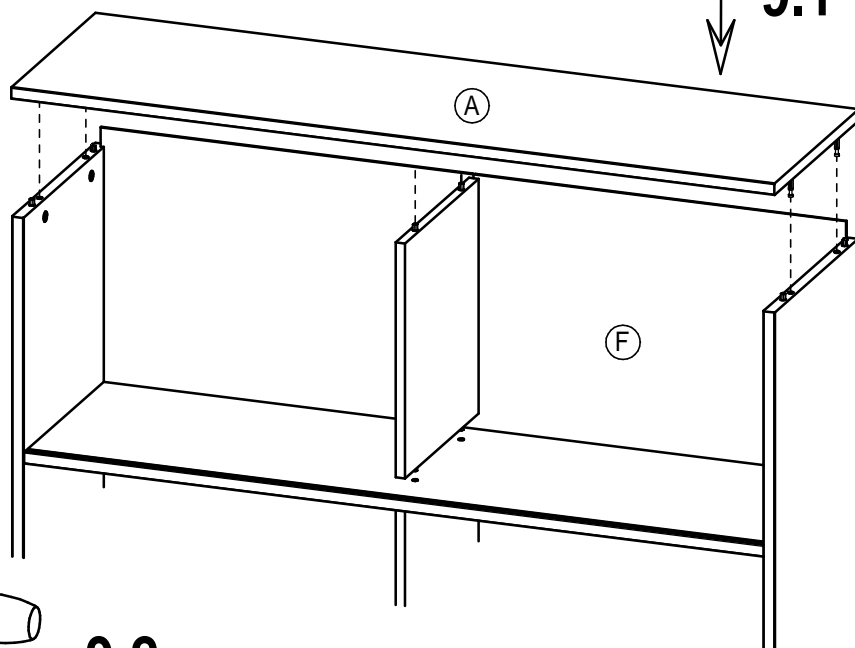

9.2

7

erstellt

Datum: 25.04.2013

geändert

Datum:

geprüft

Datum: 29.04.2013

10.

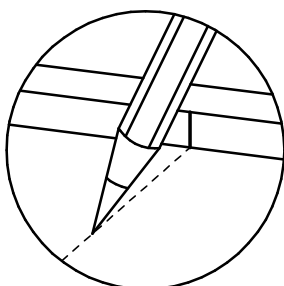
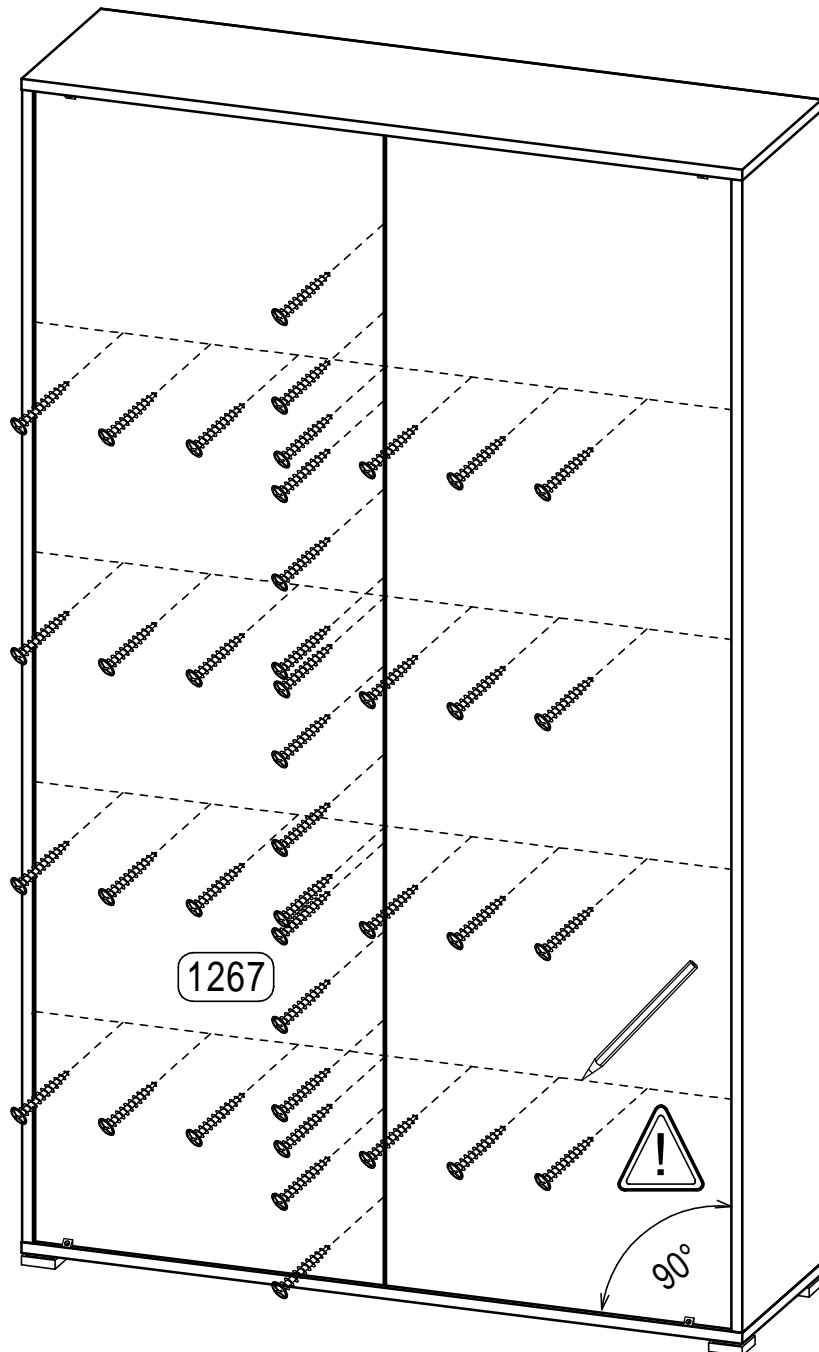
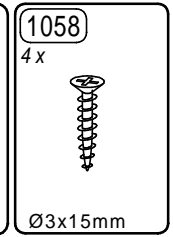
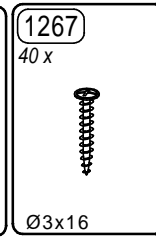
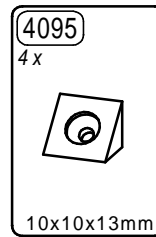
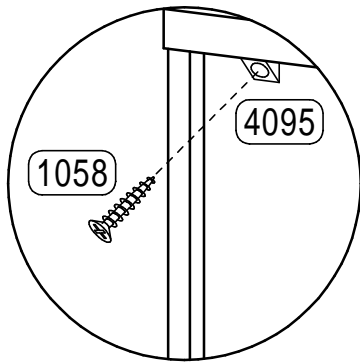

8

erstellt	geändert	geprüft
Datum: 25.04.2013	Datum:	Datum: 29.04.2013

11.

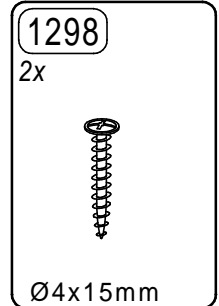
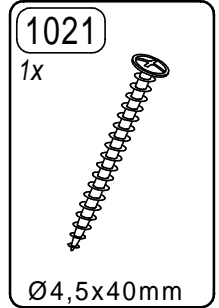
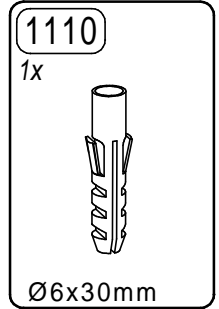
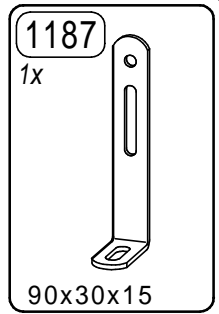
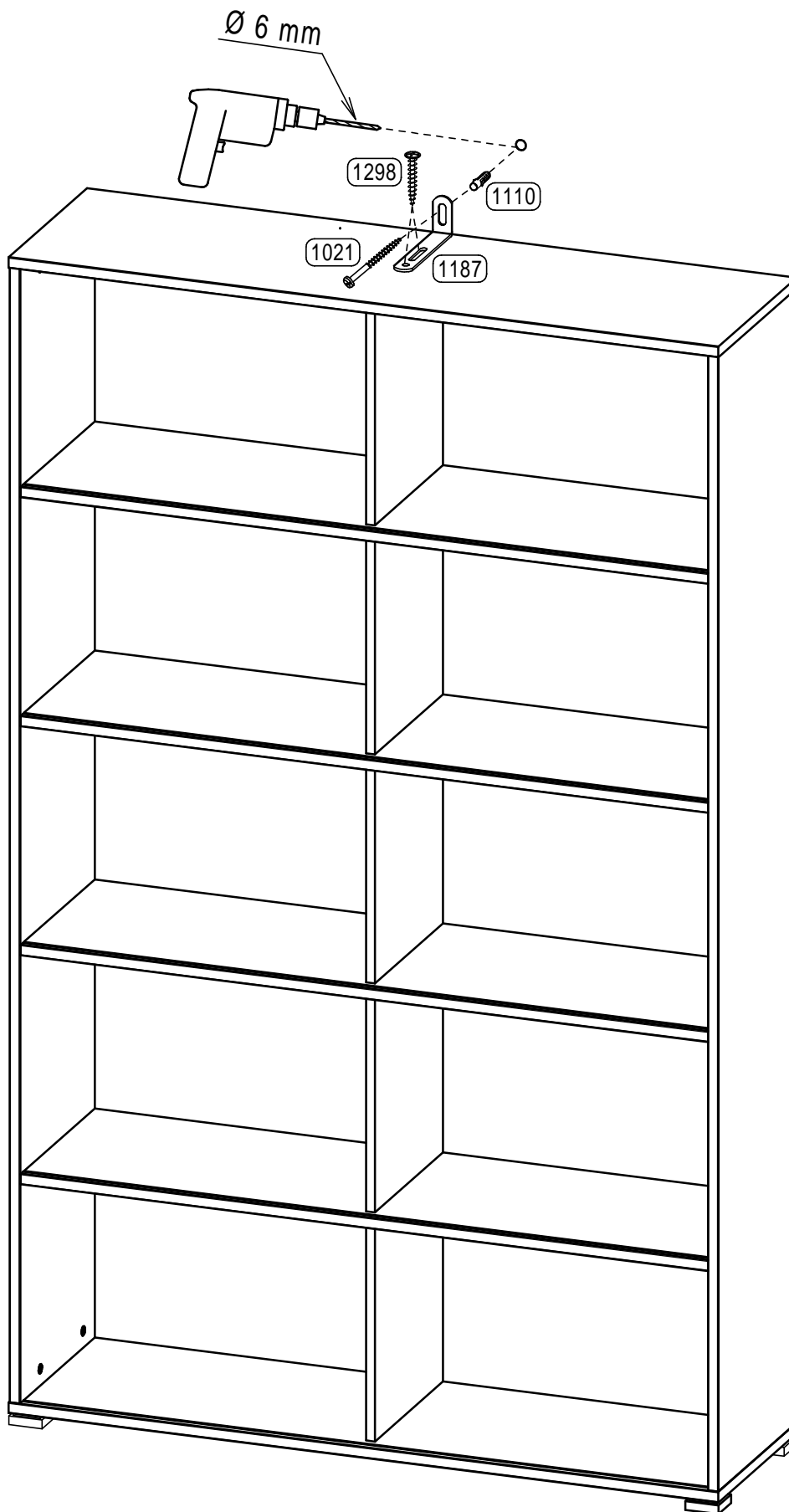

12.

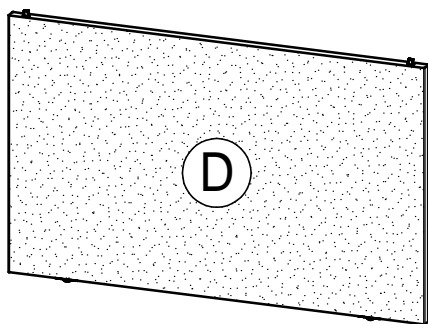
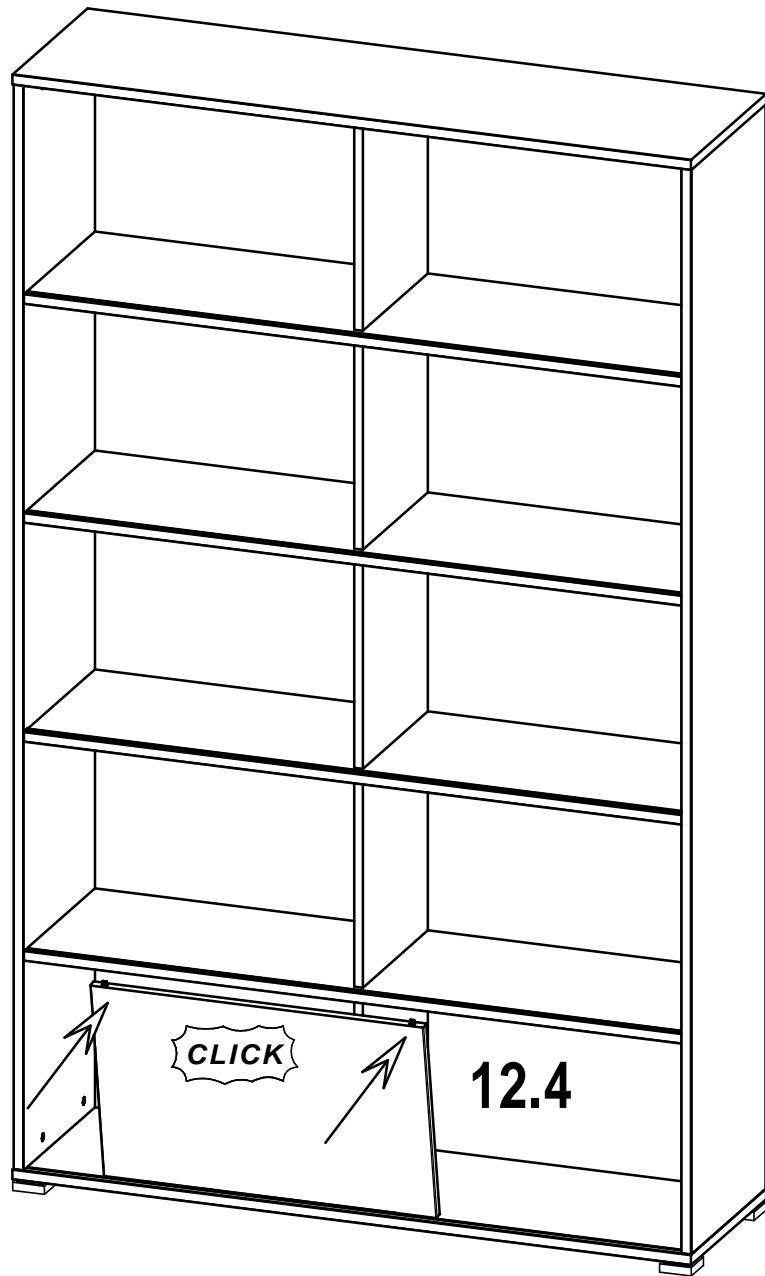
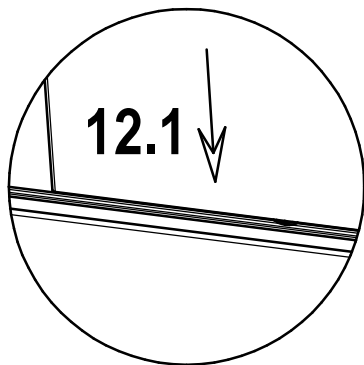
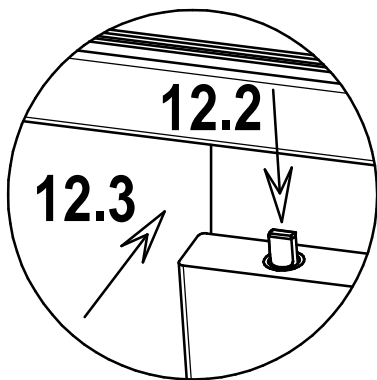

?

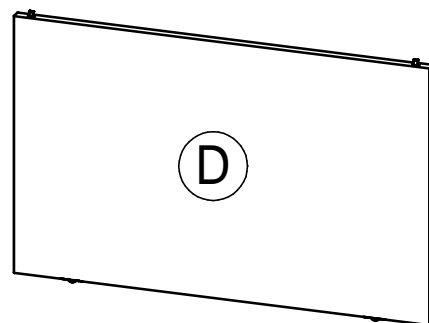

10

13.

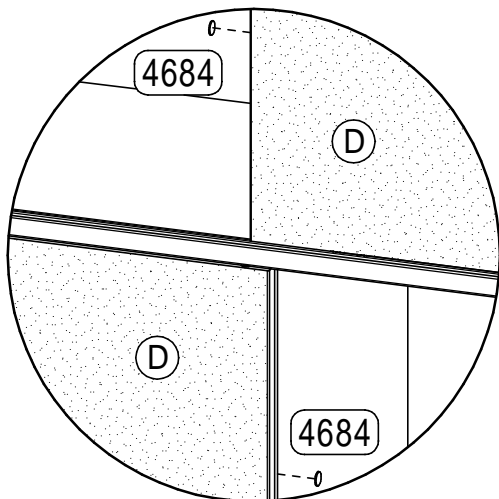
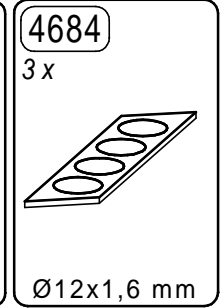
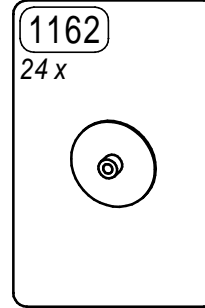
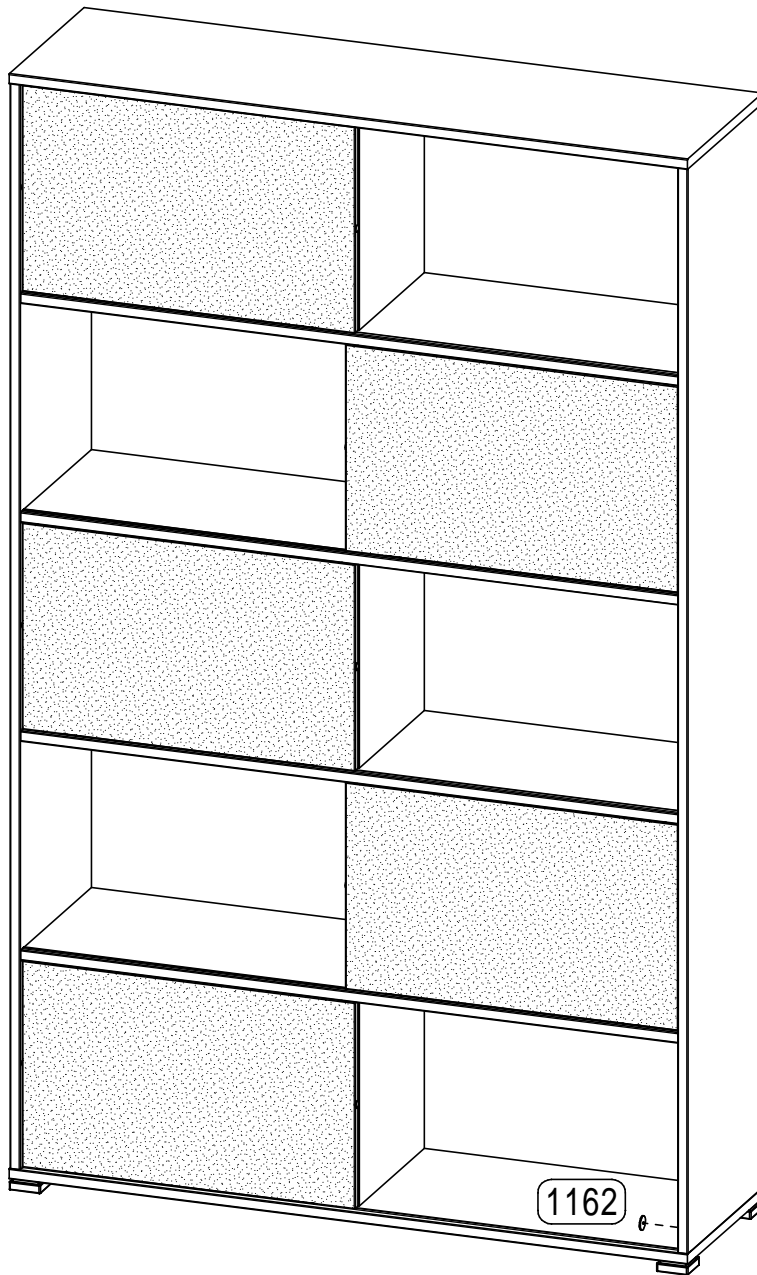

Ersatzteil-Direkt Service

(nur für Deutschland - for germany only - seulement pour Allemagne)

Sehr geehrter Kunde,
 Sollte ein Möbelteil bzw. Beschlagteil fehlen oder beschädigt sein, senden Sie uns den Artikel bitte **nicht** zurück, sondern fordern Sie der Einfachheit halber Ersatz direkt bei **GERMANIA** an.
 Tragen Sie Ihren Bedarf in die Tabelle ein und übermitteln Sie uns diese Seite per Post, per Fax, telefonisch oder per e-mail.

Bitte unbedingt die MODELL-Nr. + DEKOR-Nr. (siehe Karton) und die entsprechende Teilebezeichnung (siehe Teileliste) angeben.

Mod. Nr.: _____ Dekor-Nr.: _____



Serie
1234



Möbelteile			
Teil	beschäd.	fehlt	Anzahl
Z	X		1

Beispiel

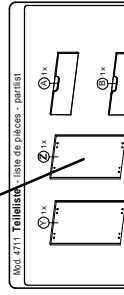

Beschlagteile			
Teil	beschäd.	fehlt	Anzahl
1162		X	2

Beispiel

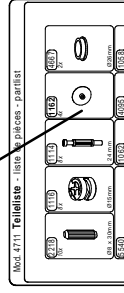

Absender nicht vergessen :

Name: _____ Strasse u. Nr.: _____
 PLZ: _____ Ort : _____
 Tel.: _____ Fax: _____ e-mail: _____

Unsere Hotline :

Tel. 05252 84939 und 05252 84962 Fax: 05252 84936
 e-mail : service@mygermania.com

GERMANIA - Service - Postfach 1160 D 33189 Schlangen

Sicherheitshinweise Safety instructions Indications de sécurité

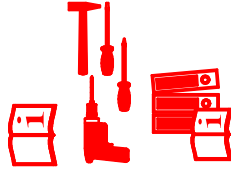

- 1.) Montageanleitung aufmerksam durchlesen
 Please read assembly instruction carefully
 Prière de bien lire la notice de montage du début à la fin
- 2.) Montage nach Montageanleitung durchführen
 Please follow the assembly instruction step by step
 Bien suivre le sens du montage indiqué sur la notice
- 3.) Montageanleitung aufbewahren
 Please save the assembly instruction
 Bien conserver la notice de montage



ACHTUNG! Beschlagteile und Beschlagteile von Säuglingen und Kindern fernhalten
ATTENTION! To avoid suffocation keep plastic bag away from children. Contains small parts which may be a choking hazard
ATTENTION! Toutes les pièces détachées livrées dans le colis être mis hors de portée des bébés des et enfants



Netzanschluss (230V) nur von einem Fachmann ausführen lassen. Sanitäranschluss nur von einem Fachmann ausführen lassen. Mains connection (230V) has to be done by an expert. Sanitary installation has to be done by an expert. L'électricité (230V) uniquement à faire par un électricien. Installation sanitaire à faire par un spécialiste.



Beiliegendes Befestigungsmaterial eignet sich nur für Massivwände. Für andere Wände müssen Spezialdübel verwendet werden. Die Festigkeit ist zu Prüfen.

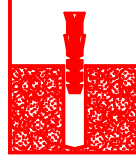

The attached fixing materials is only suitable for solid walls. For other Types of walls special dowels have to be used. The firmness have to be checked.

Le matériel de fixation ci-joint est exclusivement prévu pour des murs pleins(une fixation spéciale est nécessaire pour cloisons placo,...). La fermeté est à examiner.

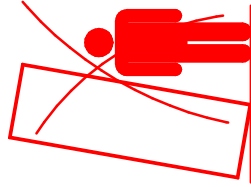

Beiliegende Wandbefestigungen dienen als Kippschutz, unbedingt anbringen!

The attached wall fixing is necessary to avoid tipping and must be fixed!

Les fixations prévues dans le colis préviennent contre le renversement du meuble. Il faut impérativement fixer le meuble au mur, afin d'éviter tout incident!

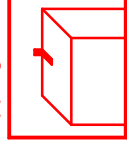

Für Schäden, die durch unsachgemäße Montage entstanden sind, übernehmen wir keine Haftung. For the damages, which have originated from improper assembly, we take over no liability. Pour les dommages qui sont nés par le montage incorrect, nous ne prenons en charge aucune responsabilité.