

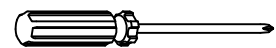

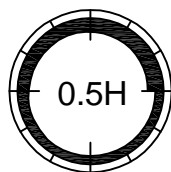

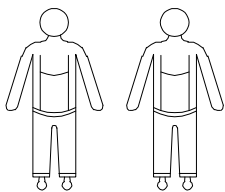

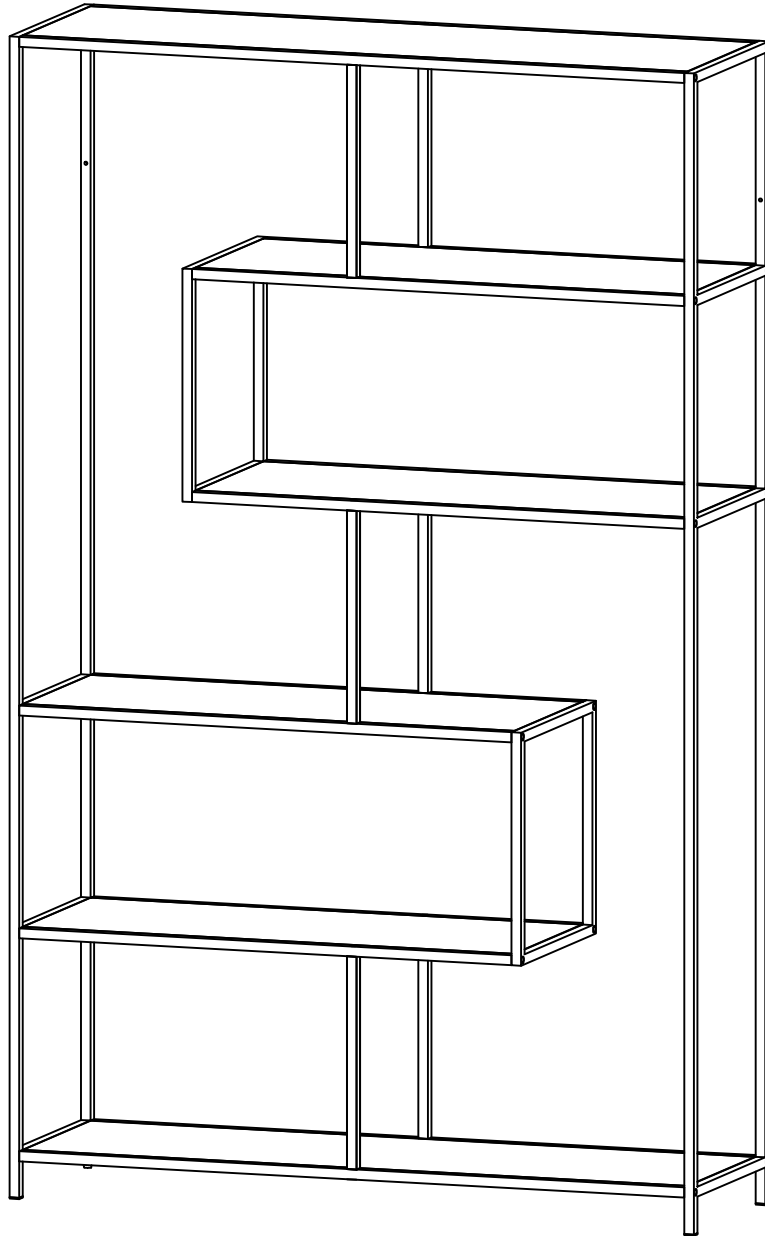

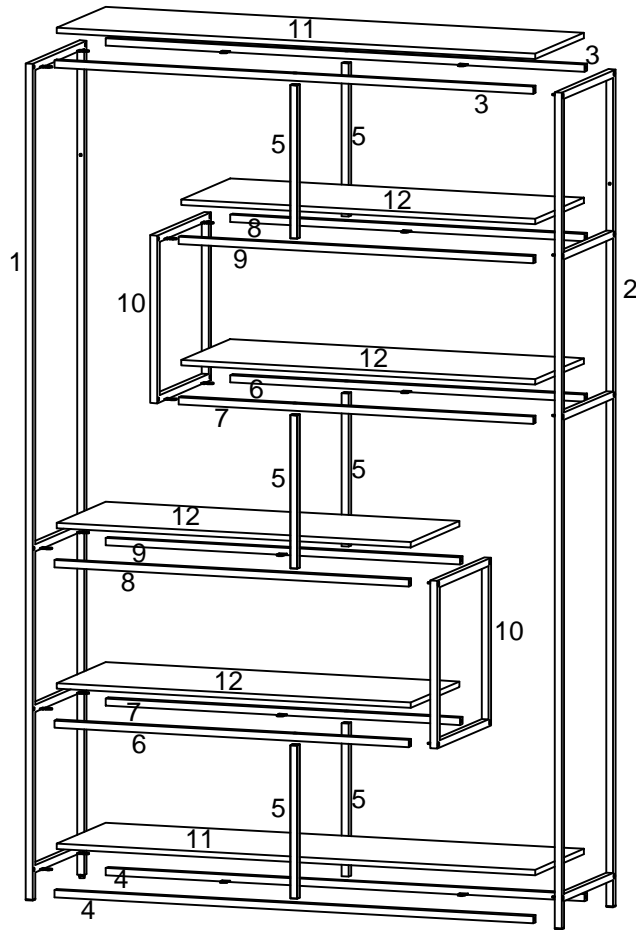







# Seaford

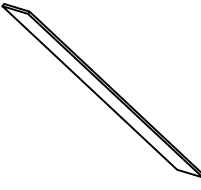



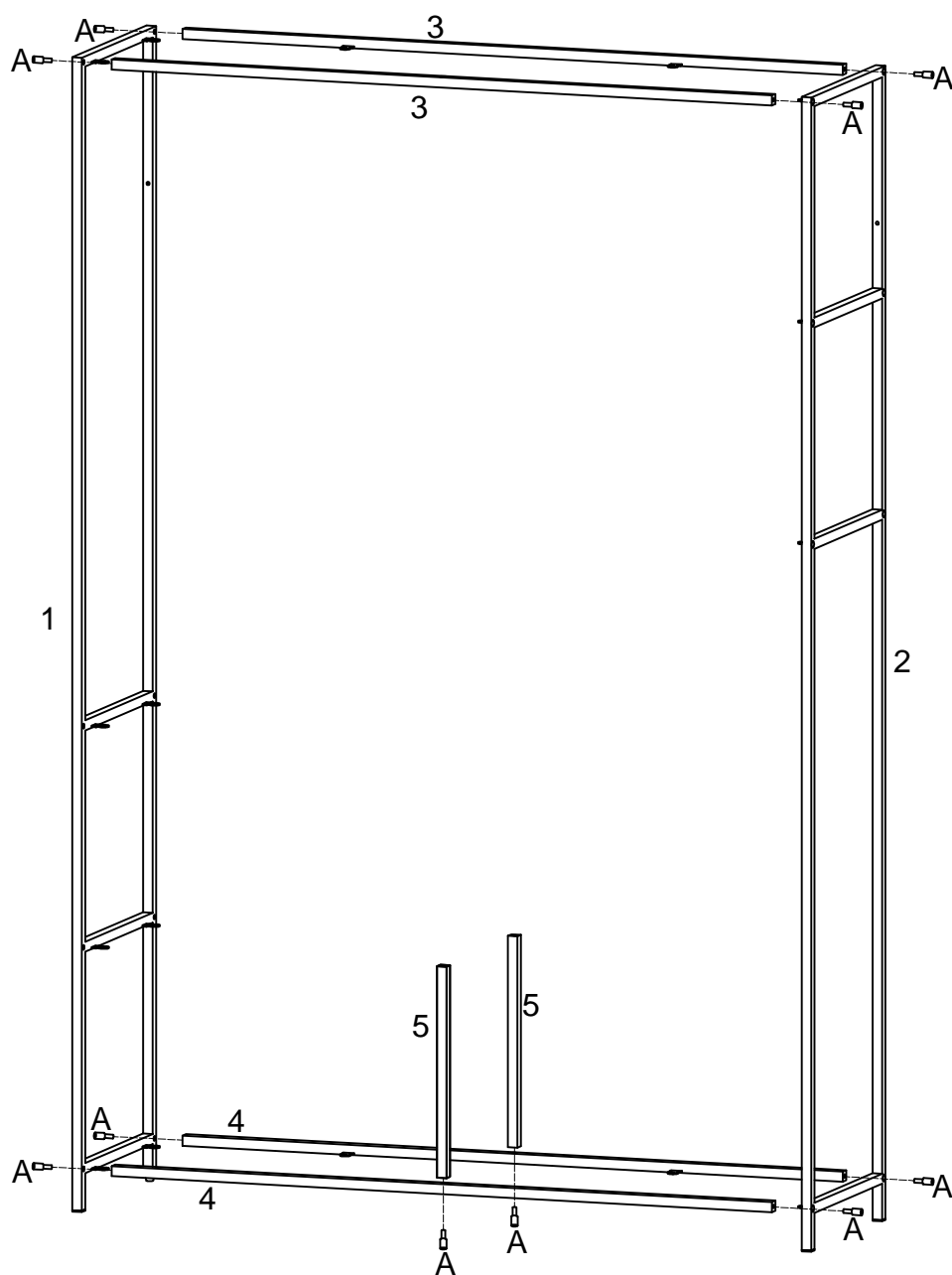
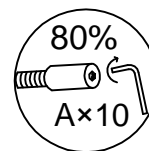

1  1PC	2  1PC	3  2PCS	4  2PCS	5  6PCS	6  2PCS
7  2PCS	8  2PCS	9  2PCS	10  2PCS	11  2PCS	12  4PCS
A M6×15mm  36PCS	B M4×10mm  40PCS	C 4mm  1PC			



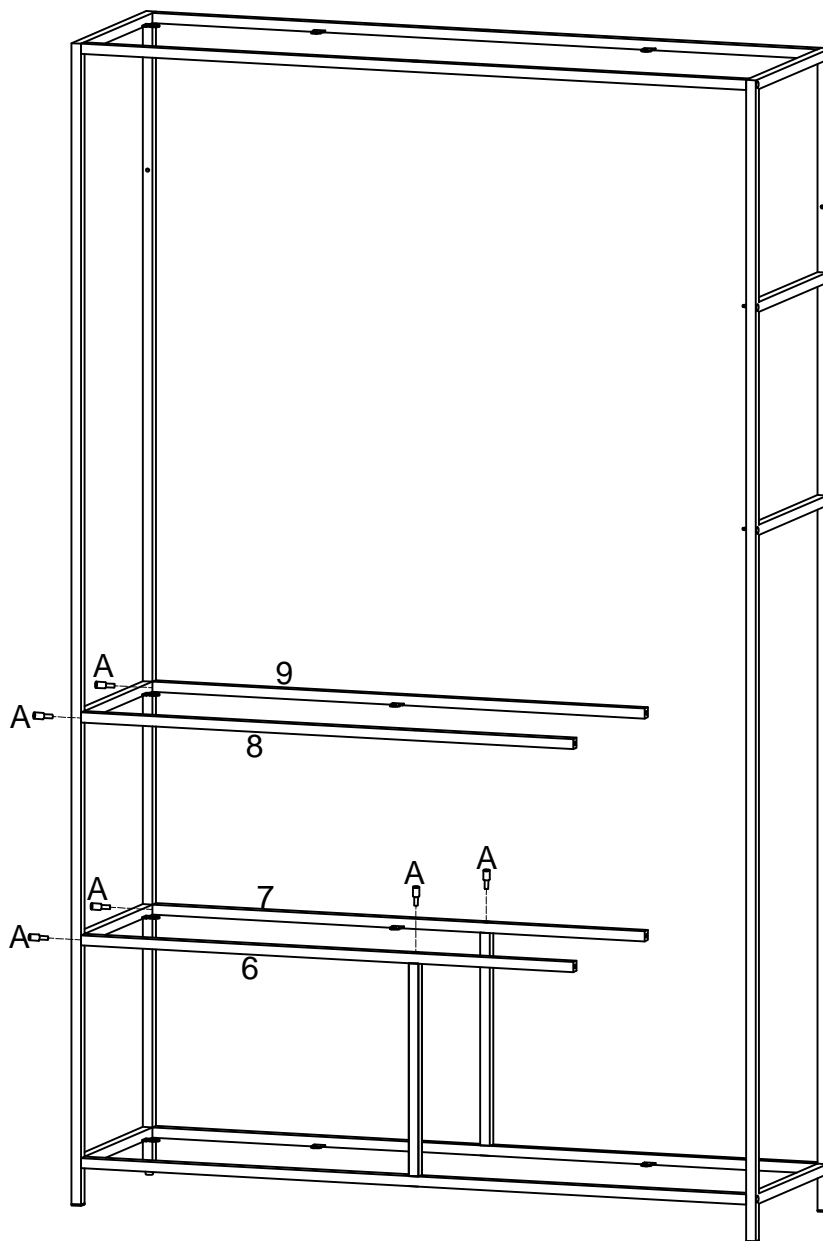
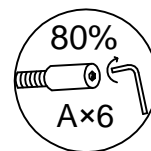

<b>A</b> M6×15mm  10PCS	<b>C</b> 4mm  1PC
---	---



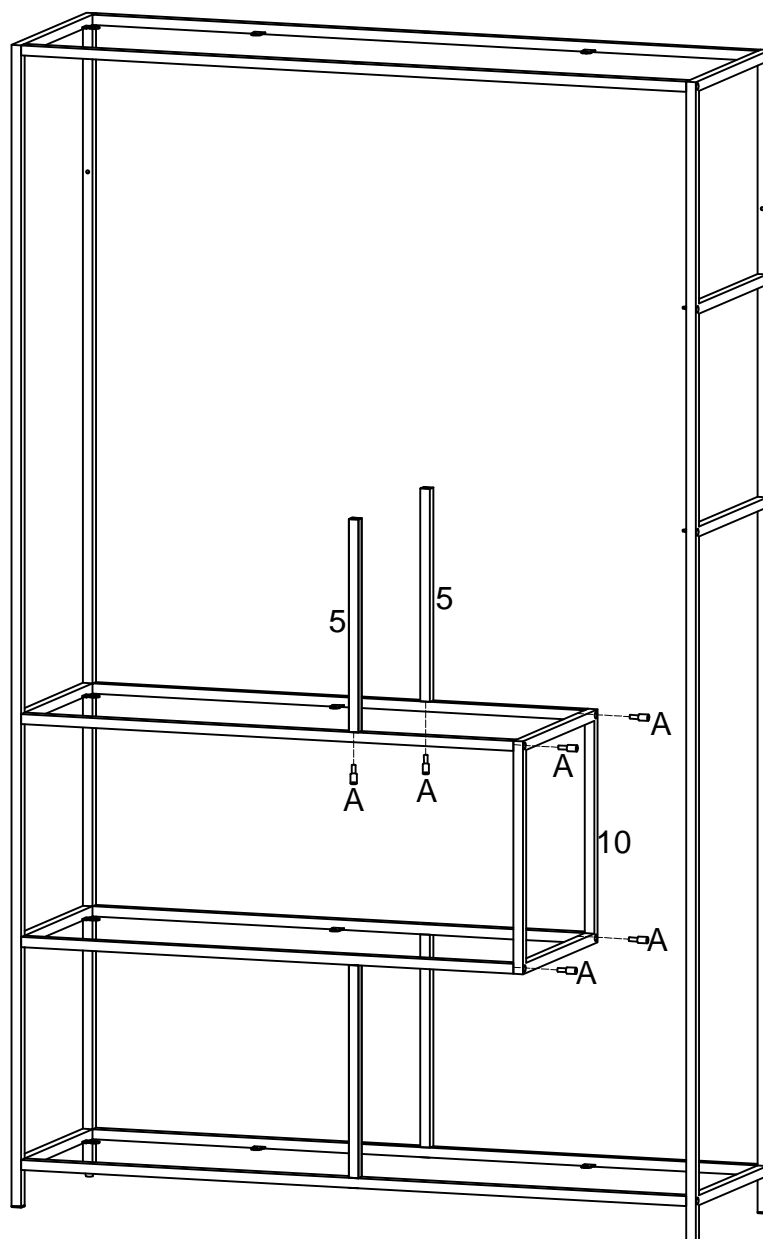
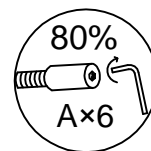

<b>A</b> M6×15mm  6PCS	<b>C</b> 4mm  1PC
--	---



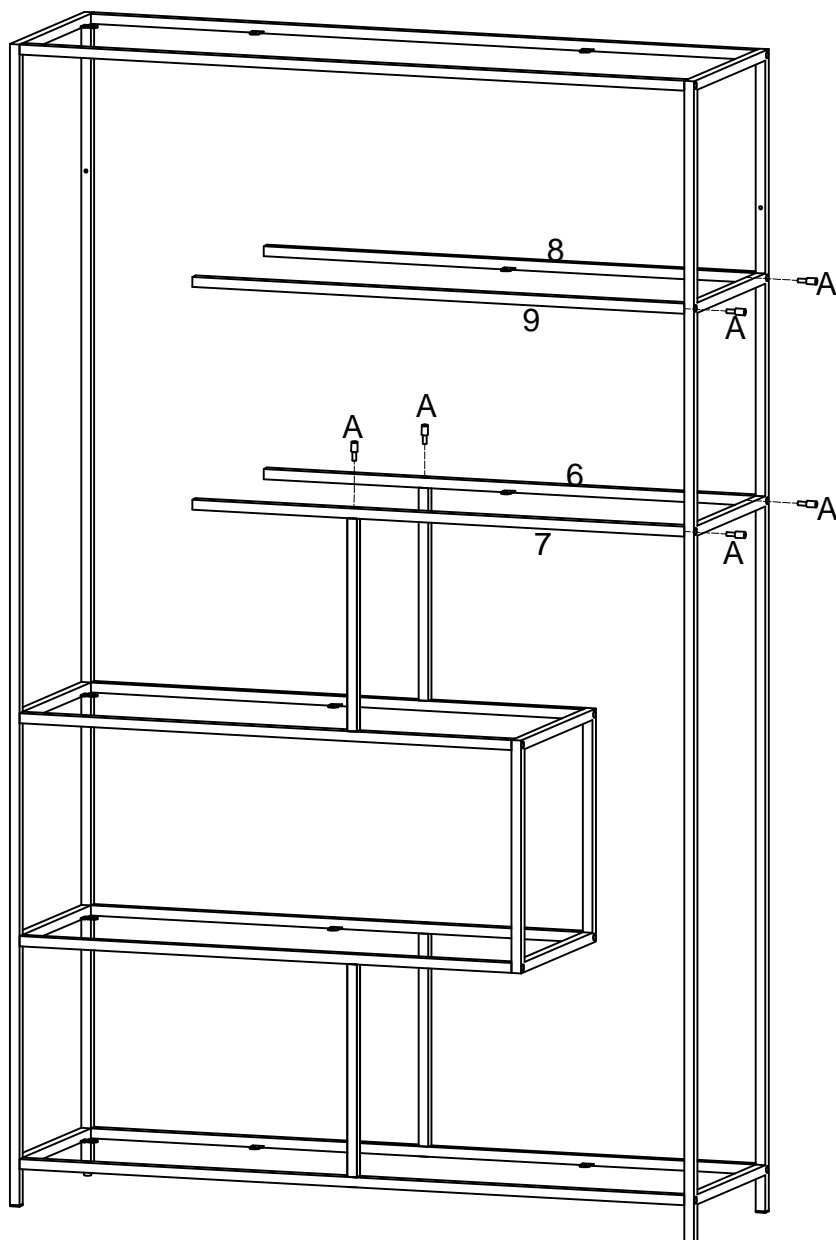
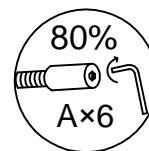

<b>A</b> M6×15mm  6PCS	<b>C</b> 4mm  1PC
--	---

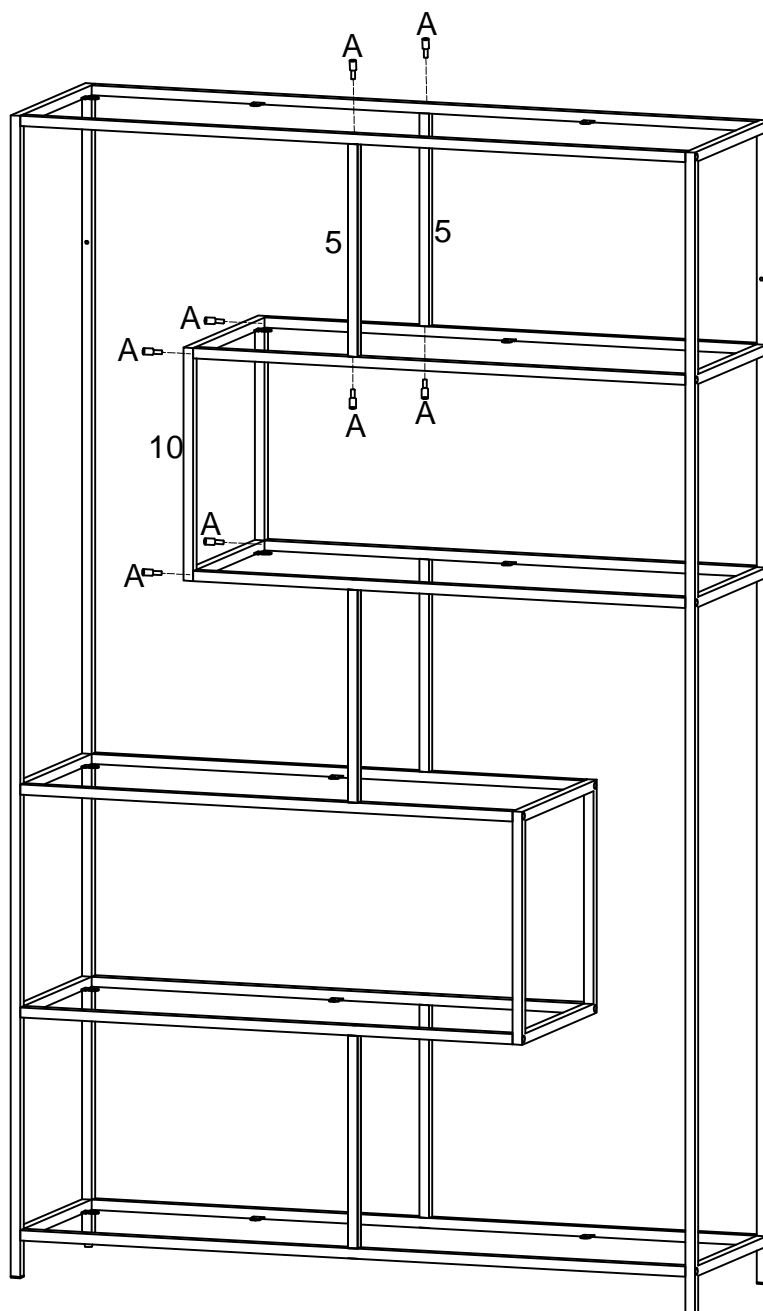
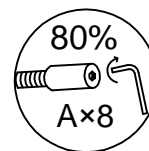

<b>A</b> M6×15mm  6PCS	<b>C</b> 4mm  1PC
--	---



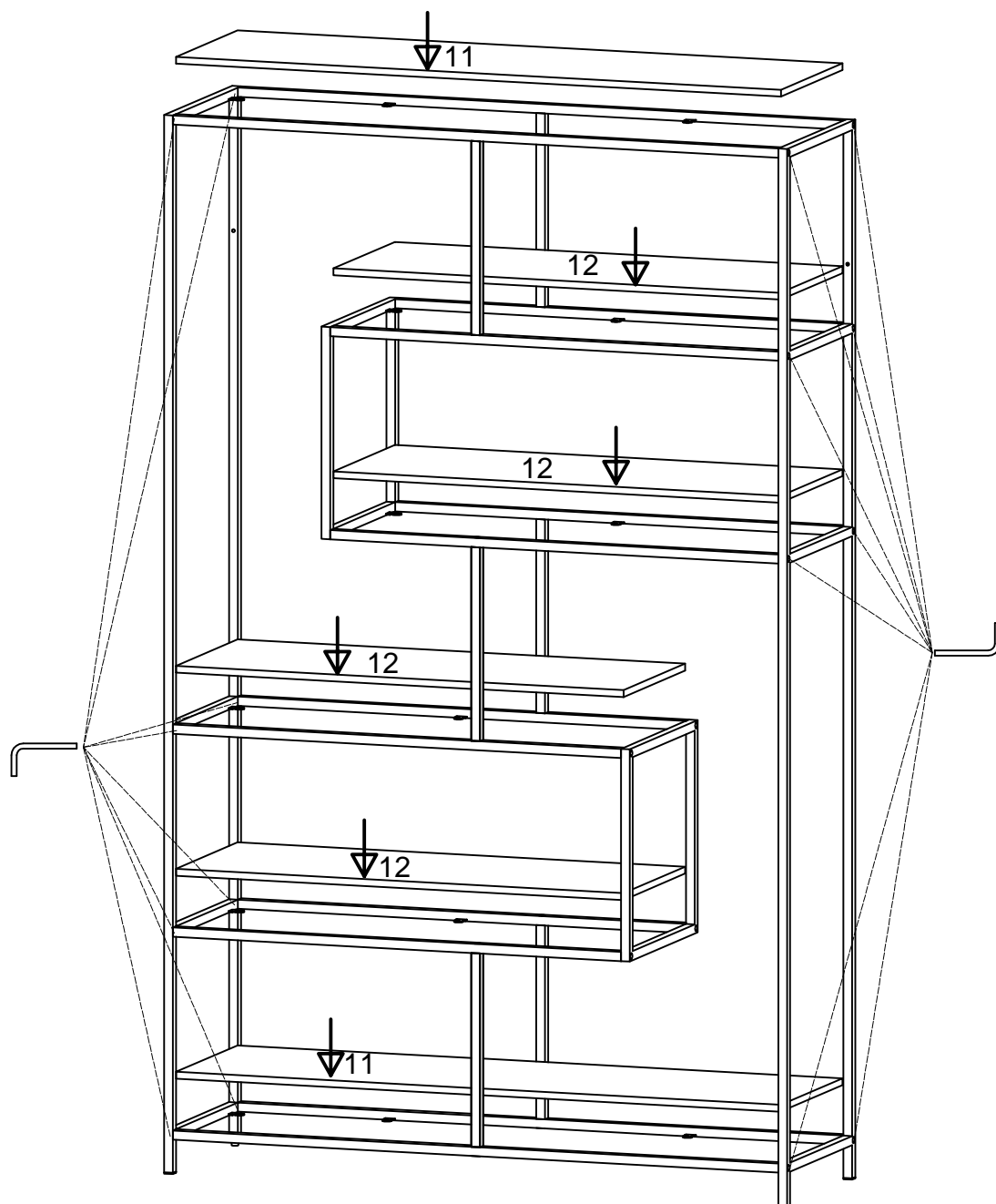
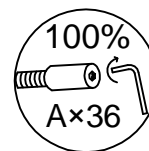

<b>A</b> M6×15mm  8PCS	<b>C</b> 4mm  1PC
--	---



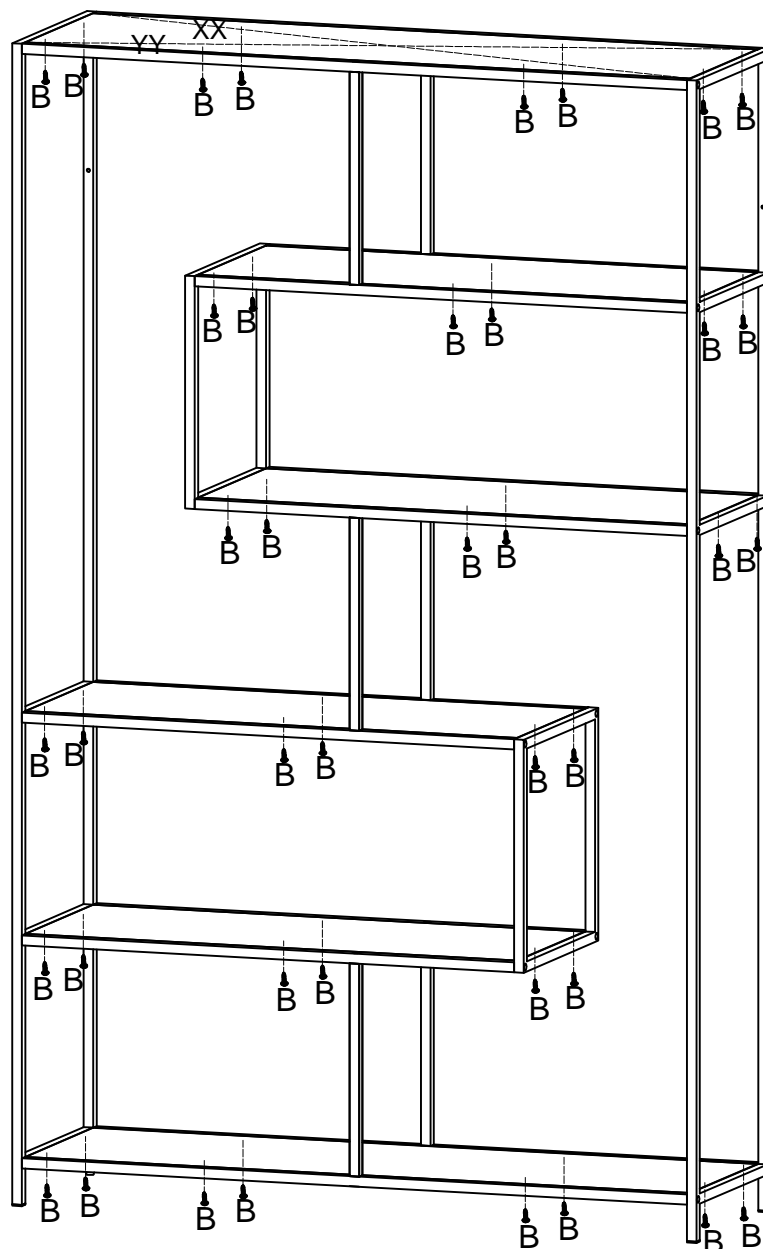
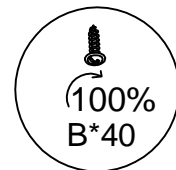

! XX=YY



**B**  
M4×10mm  
  
40PCS

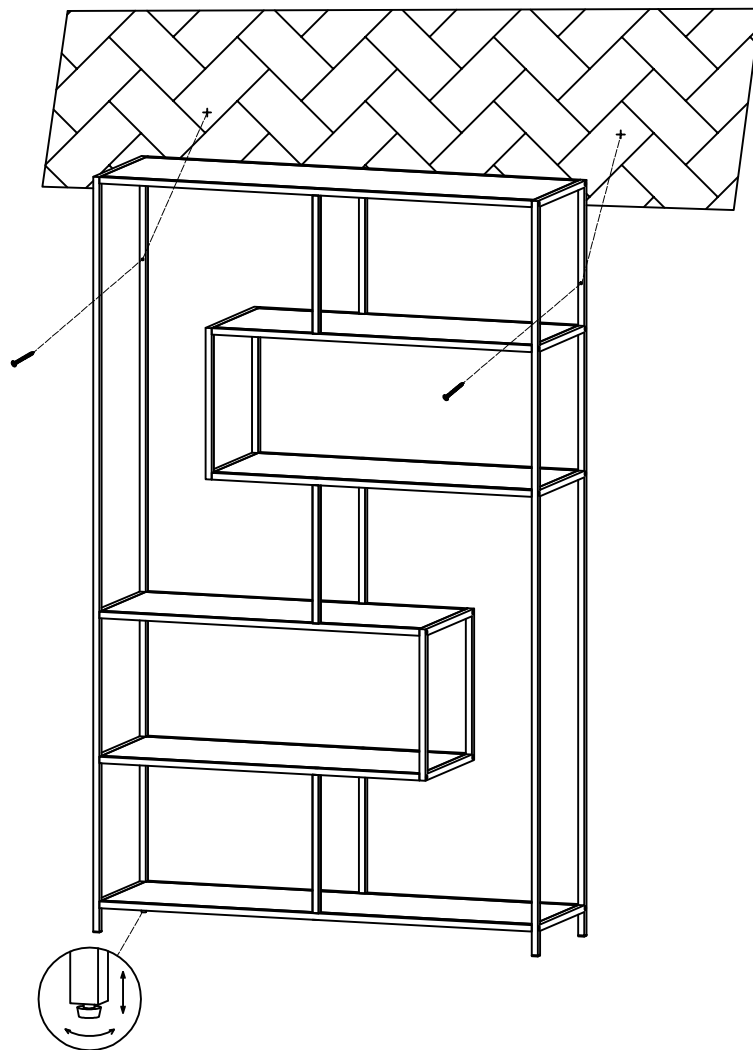
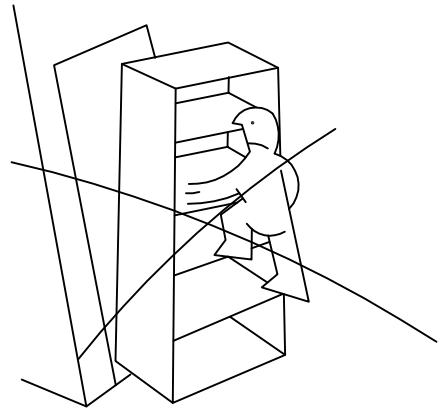
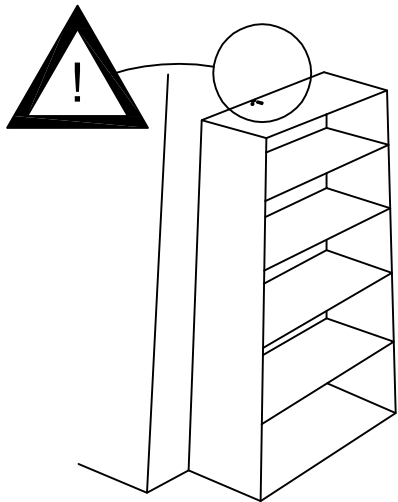

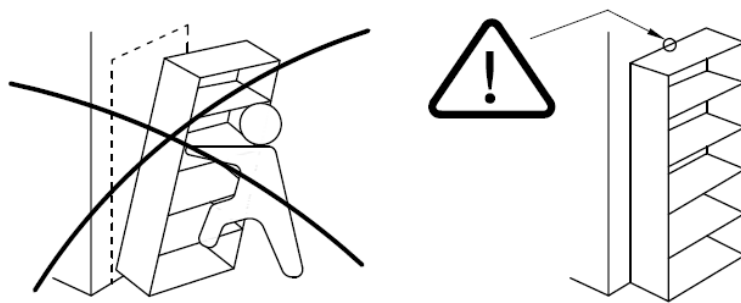

**DANSK** - VIGTIGT! Skruen som følger med væltesikringen er kun til at fæstne væltesikringen i møblet. Enkelte produkter forankres direkte i væg (uden beslag) og her vil der ikke medfølge nogen skrue. Du skal derfor supplere med en skrue eller et beslag som passer til det materiale din væg er lavet af. Hvis du er usikker så kontakt din lokale fagmand.

**ENGLISH** - IMPORTANT! The screw supplied together with the anti-topple bracket is to be used only for fixing the anti-topple bracket to the furniture. Some products are fixed directly to the wall (without bracket) and for these no screws are included. In addition to this, you will need to choose a screw or fitting which is suitable for securing the bracket to the kind of walls you have. If you are unsure about what type of screw to use contact your local hardware store.

**DEUTSCH** - WICHTIG. Die dem Kippschutz beigefügten Schrauben sind ausschließlich für die Befestigung des Kippschutzes am Möbelstück vorgesehen. Einige Produkte sind direkt an der Wand befestigt (ohne Halterungen) und es wird dafür keine Schraube mitgeliefert. Für die Befestigung des Kippschutzes an der Wand benötigen Sie zusätzlich Schrauben oder Beschläge, die zur Beschaffenheit der Wand passen. Falls Sie nicht sicher sind, welche Art von Schrauben geeignet sind, wenden Sie sich bitte an den Fachhandel.

**ESPAÑOL** – IMPORTANTE! El tornillo suministrado junto con el soporte antivuelco se debe utilizar solo para fijar el soporte antivuelco de los muebles. Algunos productos se anclan directamente en la pared (sin soportes) y no se incluirán tornillos. Además se tendrá que elegir un tornillo o accesorio que sea adecuado para asegurar el soporte correcto para el tipo de paredes en donde se fija el mueble. Si no está seguro sobre qué tipo de tornillo usar, póngase en contacto con su ferretería local.

**PORTUGUÊS** - IMPORTANTE! O parafuso fornecido com o dispositivo anti-queda deve ser usado exclusivamente para fixar este dispositivo ao móvel. Produtos que devem ser pendurados diretamente na parede vêm sem parafusos. Para fixar os móveis na parede, escolha um parafuso ou dispositivo de fixação que melhor se adapte às paredes da sua casa. Em caso de dúvida, entre em contato com a loja de ferragens mais próxima.

**SLOVENŠČINA** – POMEMBNO! Vijak, priložen konzoli za zaščito pred prevrnitvijo, lahko uporabljate le za pritrdjevanje konzole za zaščito pred prevrnitvijo na pohištvo. Nekateri izdelki so pritrdjeni neposredno na steno (brez konzole), zato njim niso priloženi nobeni vijaki. Poleg tega boste morali izbrati vijak ali pritrdilni element, ki je primeren za pritrditev konzole na vrsto sten, ki jih imate. Če ne veste, katero vrsto vijakov uporabiti, se obrnite na lokalno trgovino z opremo za dom.

**SVENSKA** - Observera att skruven som medföljer tipskyddet endast är avsedd för att fästa tipskyddet i möbelen. Vissa produkter befästs direkt i väggen (utan beslag), och der kommer inte att vara medföljande skruvar. Komplettera därför med en skruv eller ett fastbeslag som passar materialet i din vägg. Är du osäker kontakta din lokala fackhandel.

**FRANÇAIS** - IMPORTANT : La vis fournie avec le dispositif anti-bascule est destinée à être fixée sur le meuble. Certains produits, à fixer directement sur le mur, sont livrés sans visserie. Pour les fixer, il faut utiliser une vis adaptée au support mural. En cas de doute, contactez un magasin de bricolage.

**NORSK** - VIKTIG. Legg merke til at skruen som følger med tippebeskyttelsen kun skal brukes for å feste tippebeskyttelsen i møbelet. Enkelte produkter festes direkte i vegg (uten beslag), og her vil det ikke følge med skruer. Kompletter derfor med en skrue eller et fellebeslag tilpasset materialet i veggens din. Er du usikker, ta kontakt med din lokale fagforhandler.

**SUOMI** - TÄRKEÄÄ! Ruuvia, joka on toimitettu kaatumisen estävien kannatinten kanssa, on käytettävä vain kaatumisen estävien kannattimen kiinnittämiseen huonekaluun. Jotkin tuotteet kiinnitetään suoraan seinään (ilman kannatinta), eikä ruuveja ole näiden kohdalla mukana. Tämän lisäksi sinun on valittava ruuvi tai kiinnitin, joka sopi kannattimen kiinnittämiseen sellaisiin seiniin, joita sinulla on. Jos olet epävarma käytettävän ruuvien tyypistä, ota yhteys paikalliseen rautakauppaasi.

**NEDERLANDS - BELANGRIJK.** De schroeven die bij de wandbevestiging zitten, zijn uitsluitend bedoeld om de wandbevestiging aan het meubel te bevestigen. Bepaalde artikelen worden direct aan de wand bevestigd (zonder bevestigingsbeugel o.i.d.) en daarvoor worden geen schroeven meegeleverd. Completeer de wandbevestiging met een schroef of bevestigingsbeslag dat geschikt is voor het materiaal van de wand. Neem bij twijfel contact op met de ijzerhandel.

**ITALIANO - IMPORTANTE!** La vite fornita con il dispositivo antiribaltamento deve essere utilizzata esclusivamente per fissare questo dispositivo alla mobilia. I prodotti che dovrebbero essere appesi al muro vengono senza viti. Per attaccare la mobilia alla parete, scegliere una vite o un dispositivo di fissaggio che meglio si adatta alle pareti della sua casa. In caso di dubbio, contattare il negozio di ferramenta più vicino.

**ČEŠTINA – DŮLEŽITÉ!** Šroub dodávaný spolu s konzolou proti převrnutí je určen k použití pouze na upevnění konzoly proti převrnutí k nábytku. Některé výrobky se uchycují přímo ke stěně (bez konzoly) a u těchto výrobků nejsou šrouby součástí balení. Navíc si budete muset vybrat šroub nebo uchycení vhodné pro upevnění konzoly k příslušnému typu stěny. Pokud si nejste jisti, jaký typ šroubu použít, kontaktujte prosím vaše místní železářství.

**POLSKI – WAŻNE!** Śruba dołączona do wspornika zabezpieczającego przed wywróceniem się mebla służy wyłącznie do mocowania tego wspornika do mebla. Niektóre produkty są mocowane bezpośrednio do ściany (bez wspornika) i do nich śruby nie są dołączane. Ponadto niezbędny będzie wybór takich śrub lub mocowań, które nadają się do przymocowania wspornika do rodzaju posiadanych ścian. W przypadku wątpliwości dotyczących rodzaju śrub prosimy o kontakt z miejscowym sklepem z artykułami przemysłowymi.

**SLOVENSKÍ – DÔLEŽITÉ!** Skrutka dodávaná spolu s konzolou chrániacou pred prevrátením sa smie používať len na upevňovanie tejto konzoly k nábytku. Niektoré produkty sa pripevňujú priamo na stenu (bez konzoly), v takomto prípade sa nedodávajú žiadne skrutky. Okrem toho bude potrebné vybrať skrutku alebo úchytku vhodnú na zaistenie konzoly na typ steny, ktorý máte. Ak máte pochybnosti ohľadom typu skrutky, ktorý je potrebný použiť, obráťte sa na svoje miestne železiarstvo.

**MAGYAR - FONTOS!** A rögzítő konzolhoz mellékelt csavar csak a rögzítő konzol bútorhoz való rögzítéséhez használható. Egyes termékeket közvetlenül a falhoz kell rögzíteni (konzol nélkül) és ezekhez csavart nem mellékelünk. Továbbá, ki kell választani a fal típusának megfelelő csavart vagy szerelvényt a konzol felszereléséhez. Ha nem biztos benne, hogy milyen típusú csavart használjon, érdeklődjön a helyi barkácsboltban.

**TÜRK –ÖNEMLİ!** Devrilmeye karşı koruyucu braket ile birlikte verilen vida yalnızca braketin mobilyaya sabitlemek için kullanılır. Bazı ürünler doğrudan duvara sabitlenir (braket olmadan) ve bunlar için vida gerekli değildir. Buna ek olarak, braketin duvar tipinize sabitlemek için uygun bir bağlantı parçası ya da vida seçmeniz gerekecektir. Hangi tip vida kullanılacağı konusunda emin değilseniz, nalbur dükkanınıza danışın.

**РУССКИЙ – ВАЖНО!** Шурупы, поставляемые с кронштейнами против опрокидывания, предназначены только для монтажа кронштейнов против опрокидывания к мебели. Некоторые изделия крепятся непосредственно к стене (без кронштейнов). Для таких изделий шурупы не прилагаются. Кроме того, вам будет необходимо подобрать подходящий шуруп или крепление для монтажа кронштейна к стене в зависимости от материала, из которого она изготовлена. Если вы сомневаетесь в выборе шурупов, проконсультируйтесь с продавцом в строительном или хозяйственном магазине.

**RUMANIAN - IMPORTANT!** Șurubul livrat împreună cu suportul anti-răsturnare trebuie folosit doar pentru fixarea suportului anti-răsturnare pe mobilă. Unele produse sunt fixate direct pe perete (fără suport), iar pentru acestea nu sunt incluse șuruburi. Mai mult decât atât, veți avea nevoie să alegeți un șurub sau o garnitură care să fie adecvate pentru fixarea suportului pe tipul de perete pe care îl aveți. Dacă nu sunteți siguri ce tip de șurub să folosiți, contactați magazinul local de materiale de construcții.