

A S356-SZF3D3S

LUCA BABY

58-059-B5

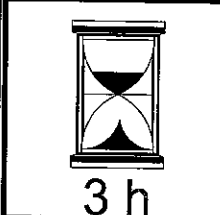
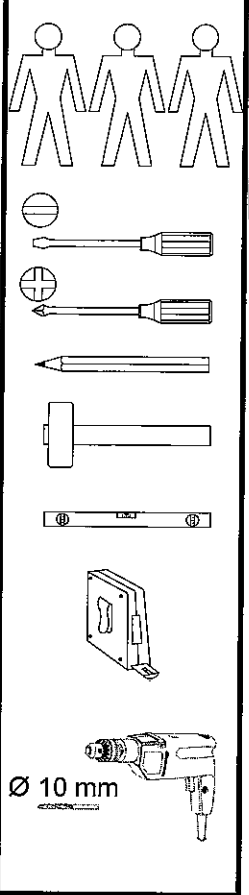

492255 00

LUCA

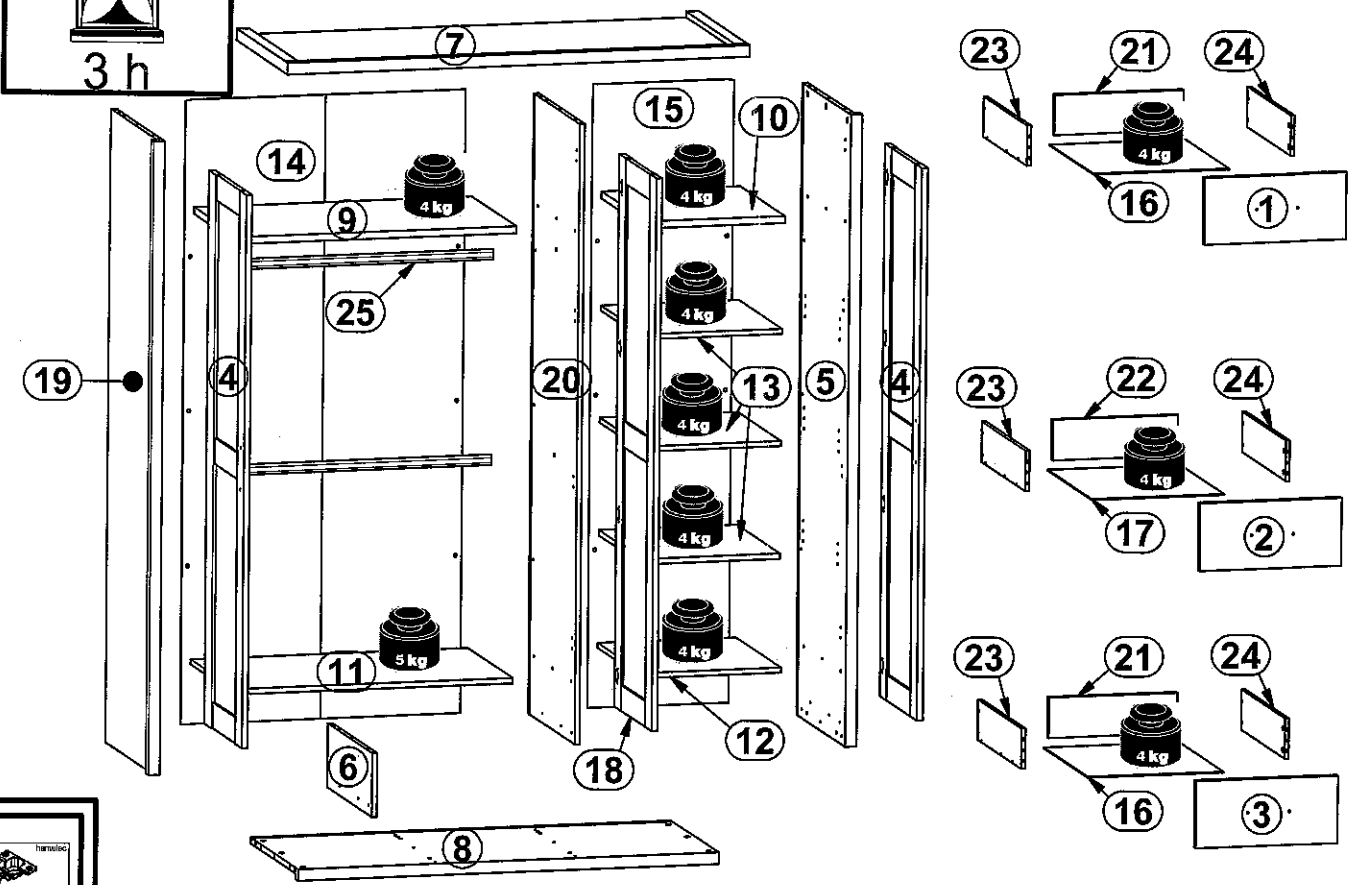

A	B	C (mm)		D
1	S328-005	444	200	4/4
2	S328-006	444	200	4/4
3	S328-007	444	200	4/4
4	S328-011	1716	444	4/4
5	S328-117	1964	585	1/4
6	S328-119	198	541	3/4
7	S328-205	1480	615	2/4
8	S328-310	1348	577	2/4
9	S328-311	890	541	2/4
10	S328-312	442	541	2/4
11	S328-313	890	541	3/4
12	S328-314	442	541	3/4
13	S328-315	441	520	3/4
14	S328-910	1938	899	1/4
15	S328-911	1938	451	1/4
16	S328-912	415	505	1/4
17	S328-913	405	505	1/4
18	S356-0010	1716	444	4/4
19	S356-1014	1964	585	1/4
20	S356-1015	1928	557	1/4
21	ZS3-5533	393	120	3/4
22	ZS3-5640	383	120	3/4
23	ZS4-505	500	120	3/4
24	ZS4-506	500	120	3/4
25	dr-885x30	885	30	2/4

4x K16, 435 a101	2x K9, 435 a103	4x K15 a43	2x K9, 5 a68	2x D1, 3 b33	4x D1 b35
6x b59	5x 128 mm c406	12x Ø5x17 mm d1	18x d20	24x d28	12x Ø5x13 mm e3
16x Ø8x30 mm f1	6x Ø6x30 mm f9	12x Ø6,5x40 mm f25	10x M4x25 mm j8	6x k1	2x M6Ø14x14 mm k39 2
24x Ø15x12 mm #16 r1	12x Ø12x10,5 mm #12 r15	36x 2011 r42	3x 500 mm w26 CL	3x 500 mm w26 CR	3x 500 mm w26 DL
			3x 500 mm w26 DR	2x Ø5x60 mm p17	2x Ø10x50 mm f35
				2x Ø3,5x13 mm p1	4x Ø3,5x10 mm n158
				13x Ø3,5x18 mm p38	24x Ø3,5x15 mm p51
				6x Ø3x12 mm p54	

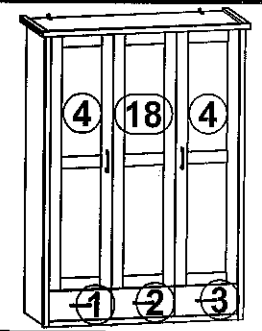
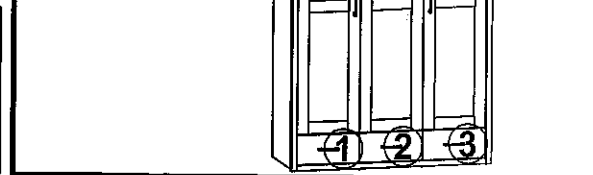

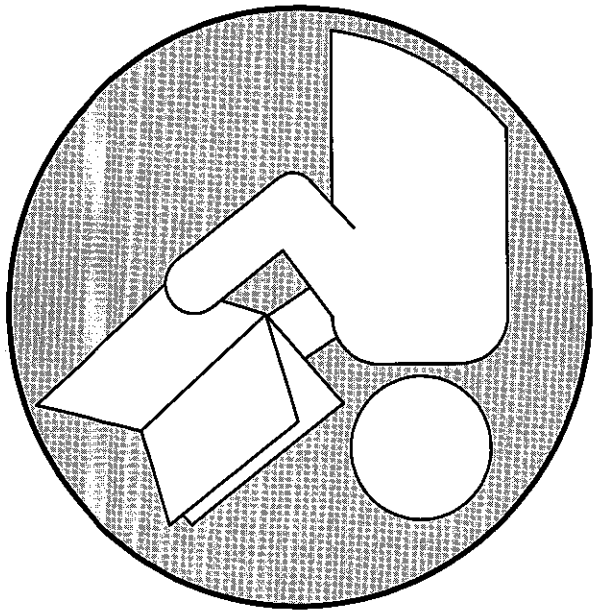
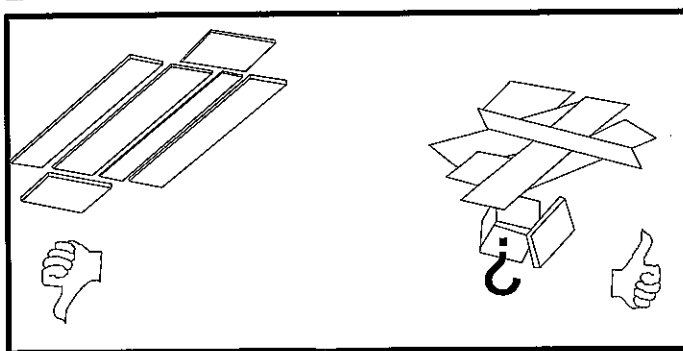
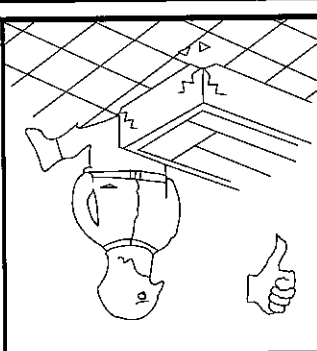
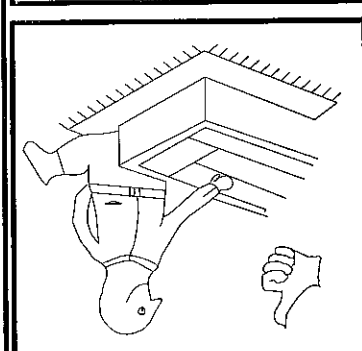
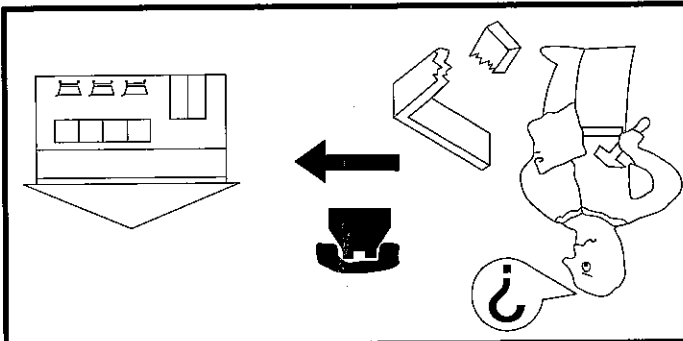
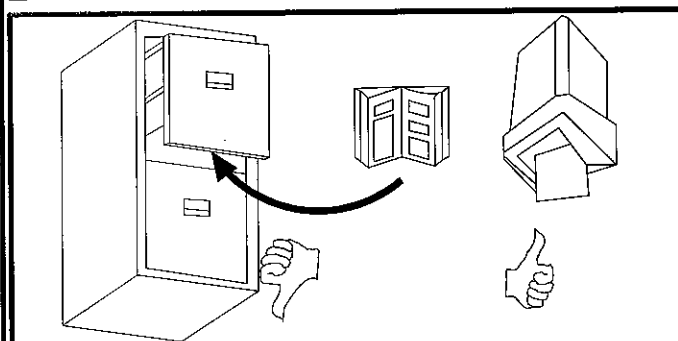
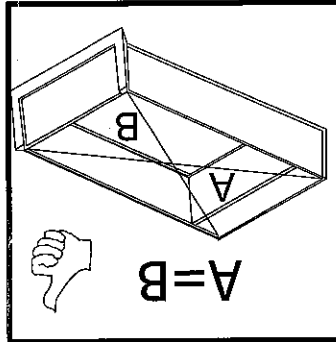
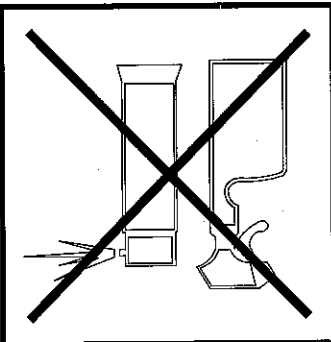
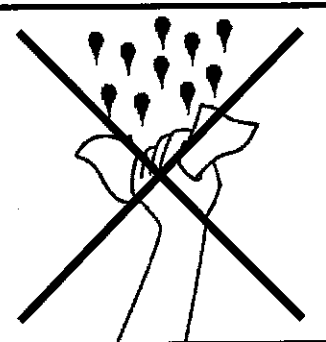
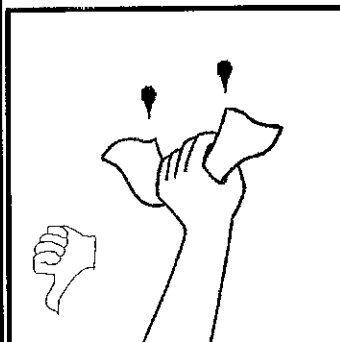
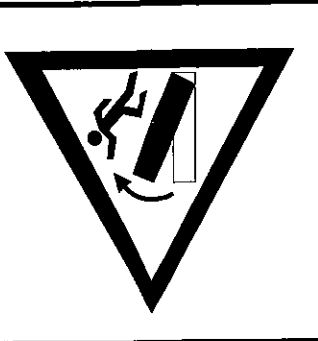
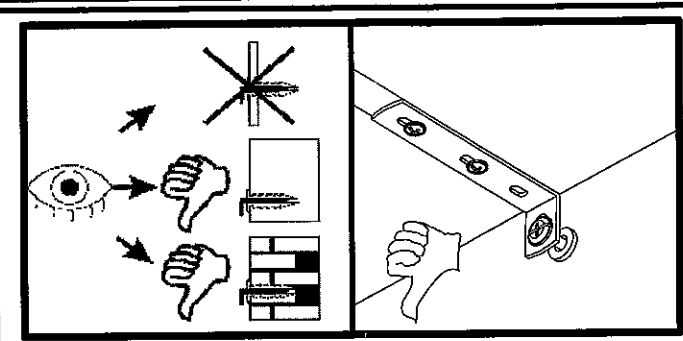
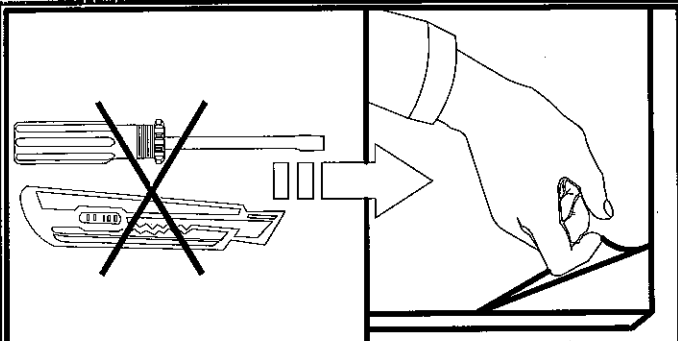

1

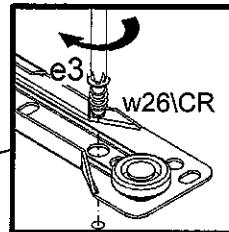
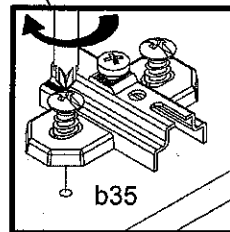
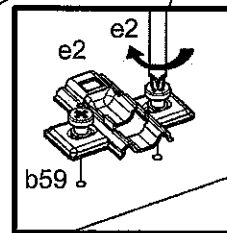
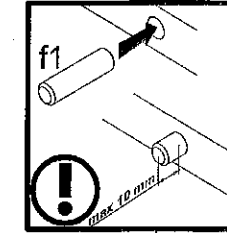
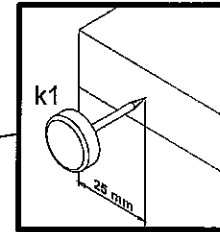
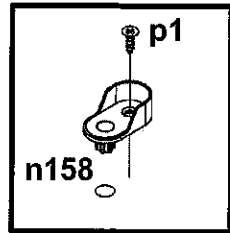
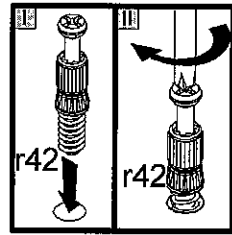

5

19

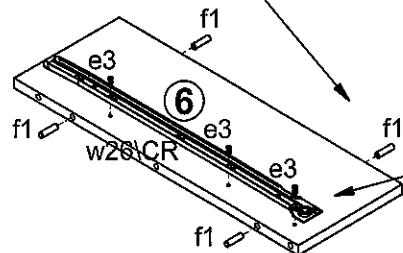
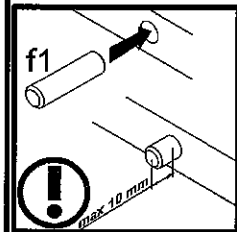

4x	4x	12x	9x
$\varnothing 6,3 \times 10$ mm	$\varnothing 8 \times 30$ mm		$\varnothing 6,3 \times 13$ mm
12x	8x	4x	2x
$\varnothing 6,3 \times 10$ mm			
2x	1x	2x	6x
$\varnothing 3,5 \times 13$ mm	500 mm	500 mm	$\varnothing 11$

2

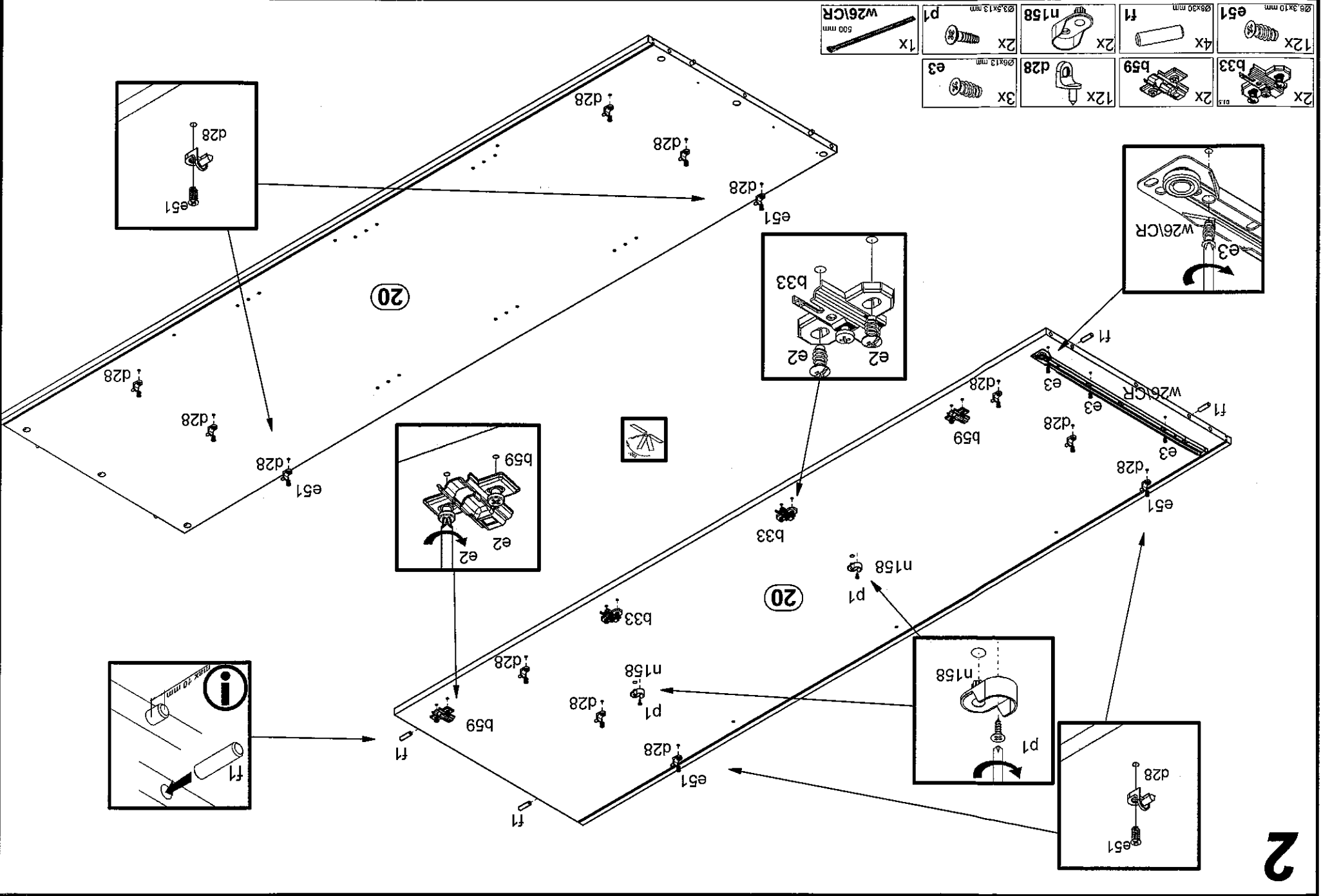

S356-SZF3D3S

LUCA BABY

58-059-B5

5/13

3

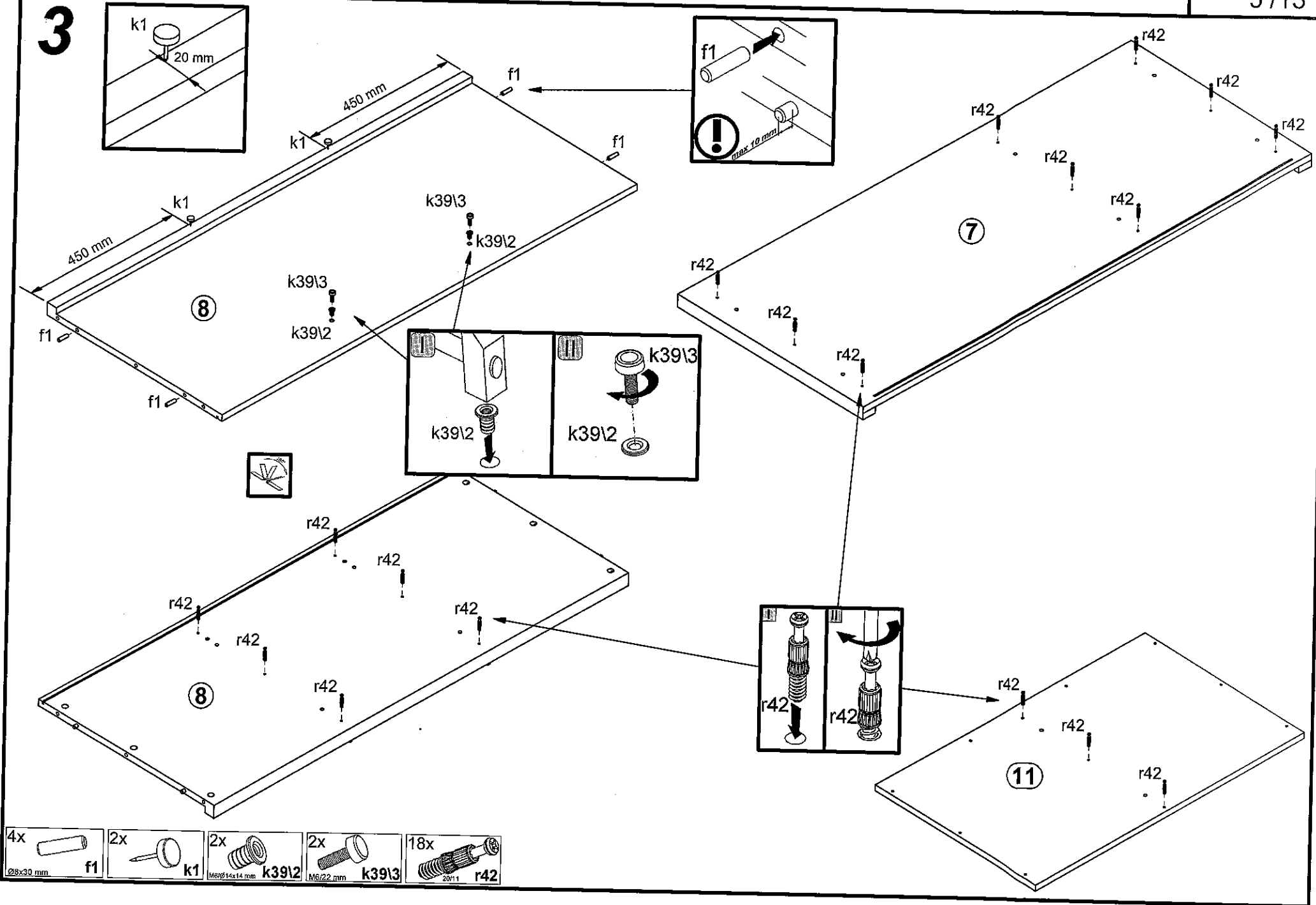

- 4x Ø8x30 mm f1
- 2x k1
- 2x M6/14x14 mm k3912
- 2x M6/22 mm k3913
- 18x 20/11 r42

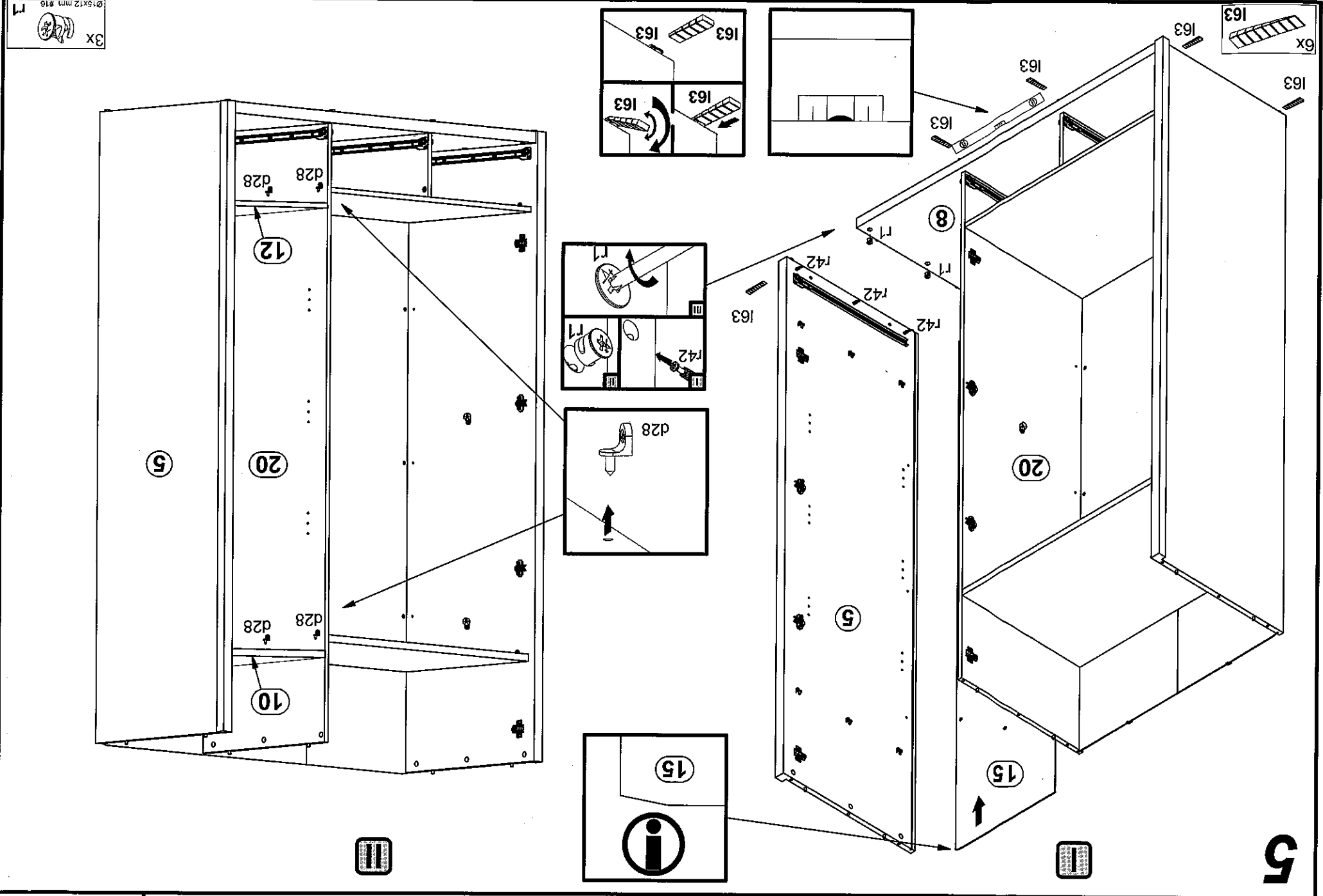

6

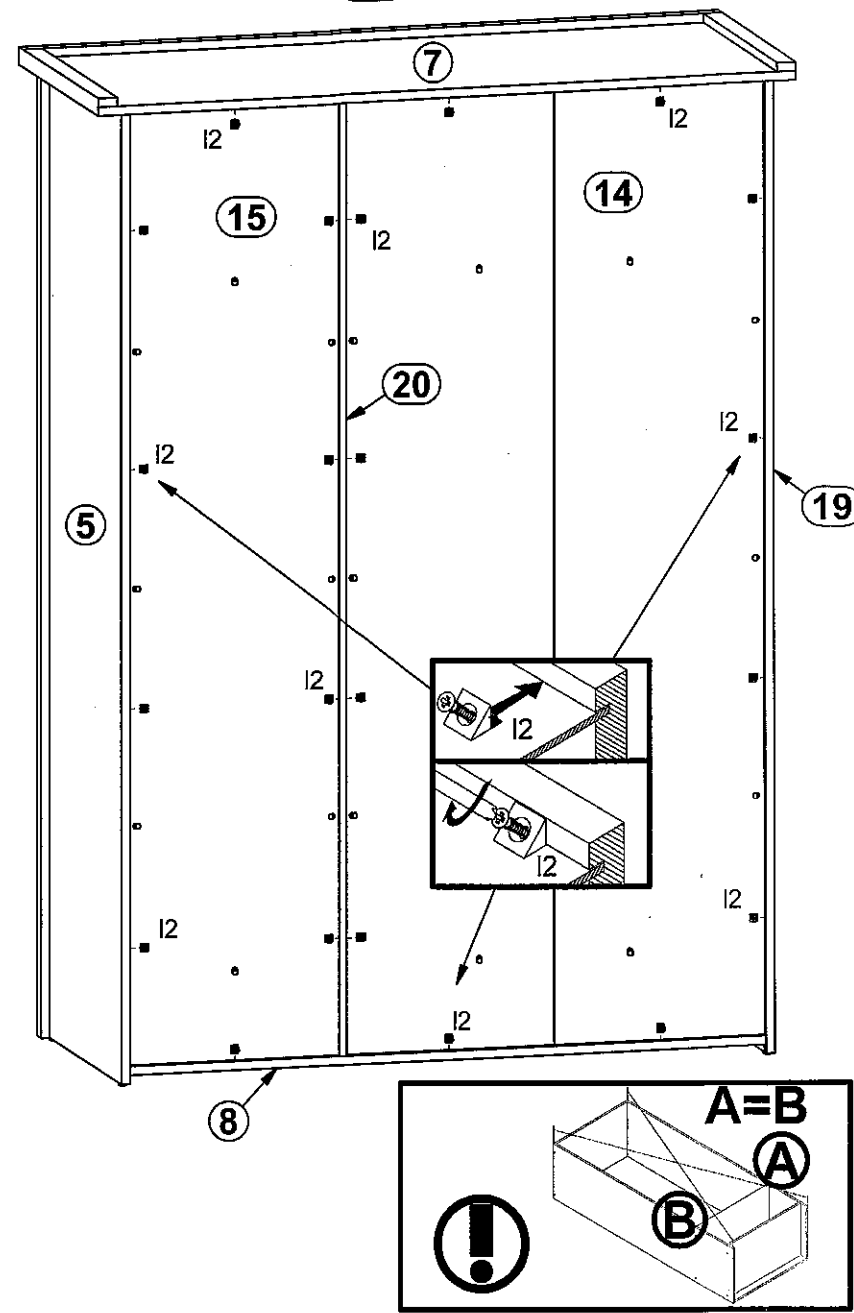
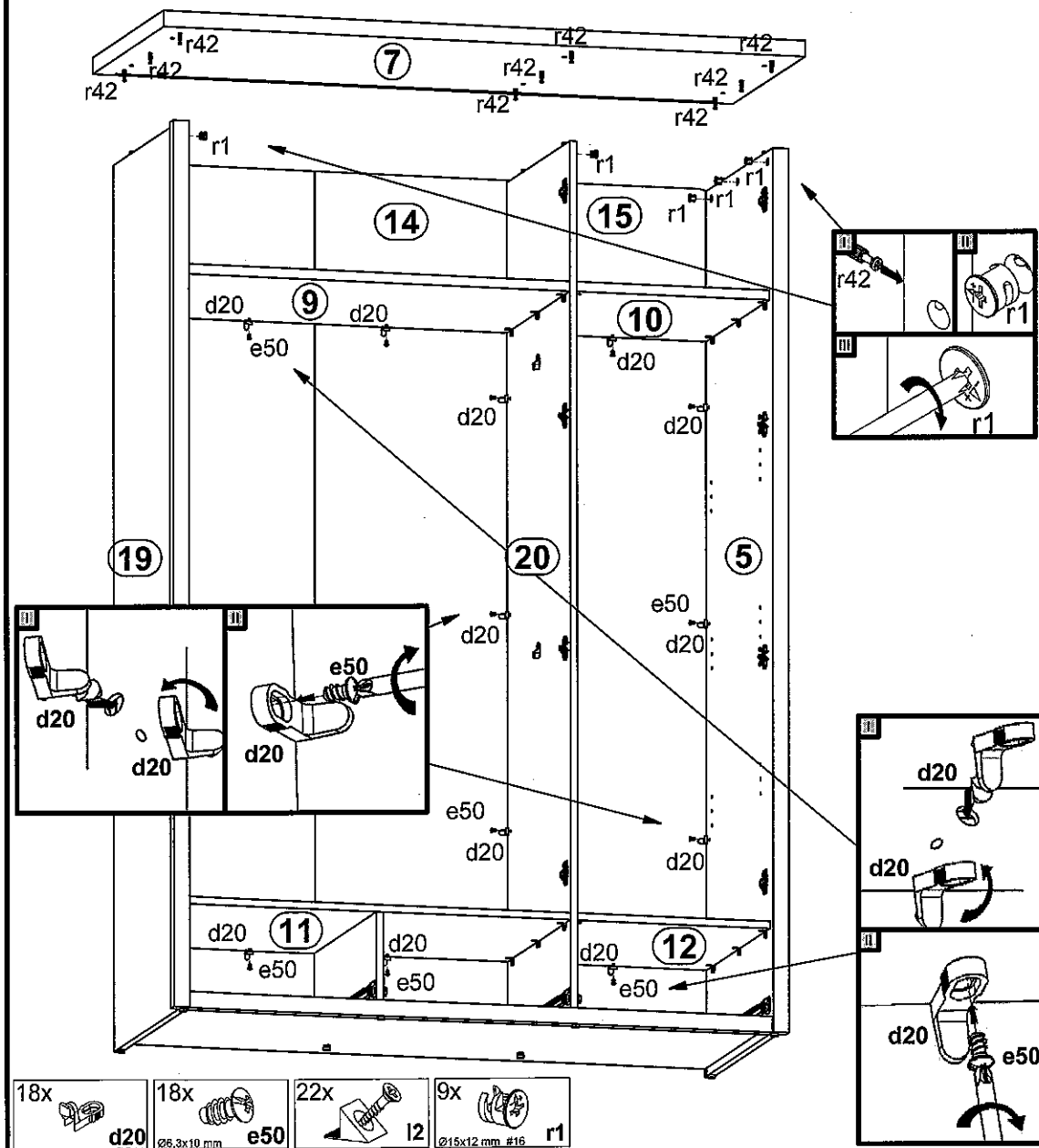

7

2x 128 mm c406	4x M4x25 mm j8
4x x16 a43	4x x16; p35 a101
16x Ø3,5x16 mm p51	

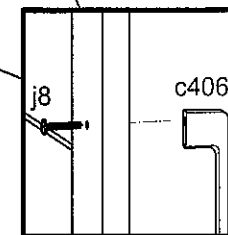
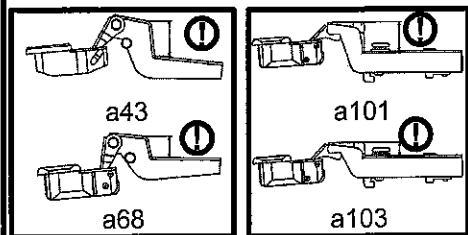
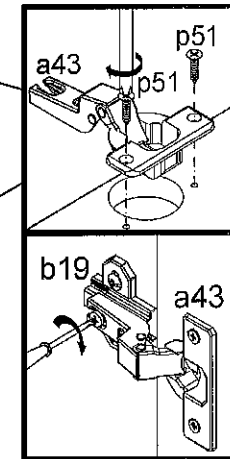
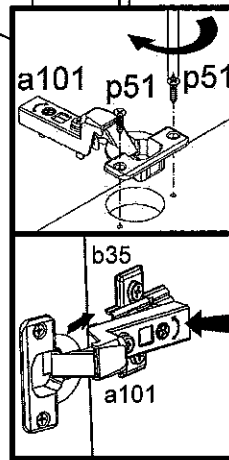
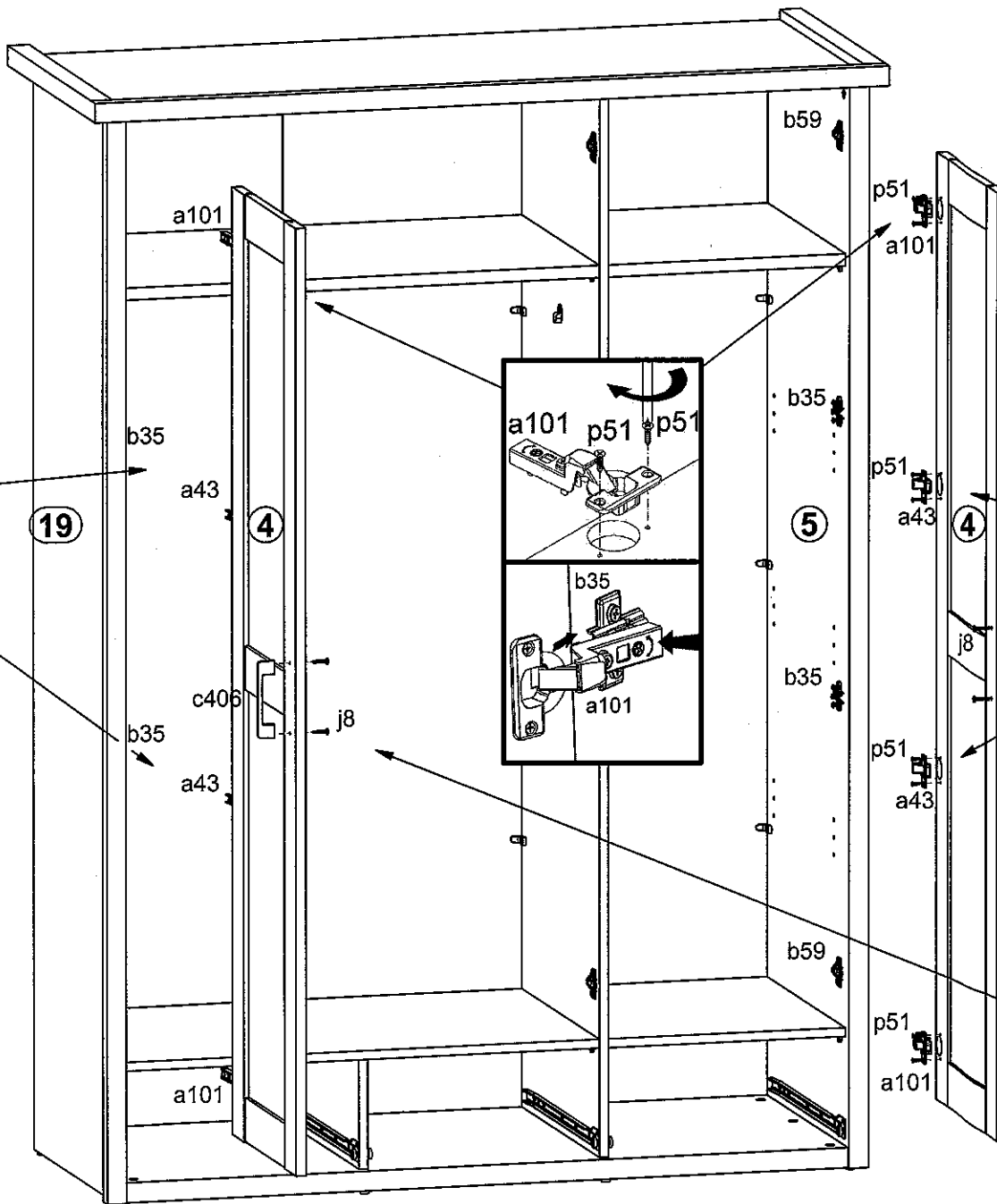
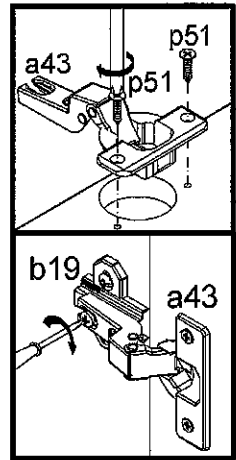

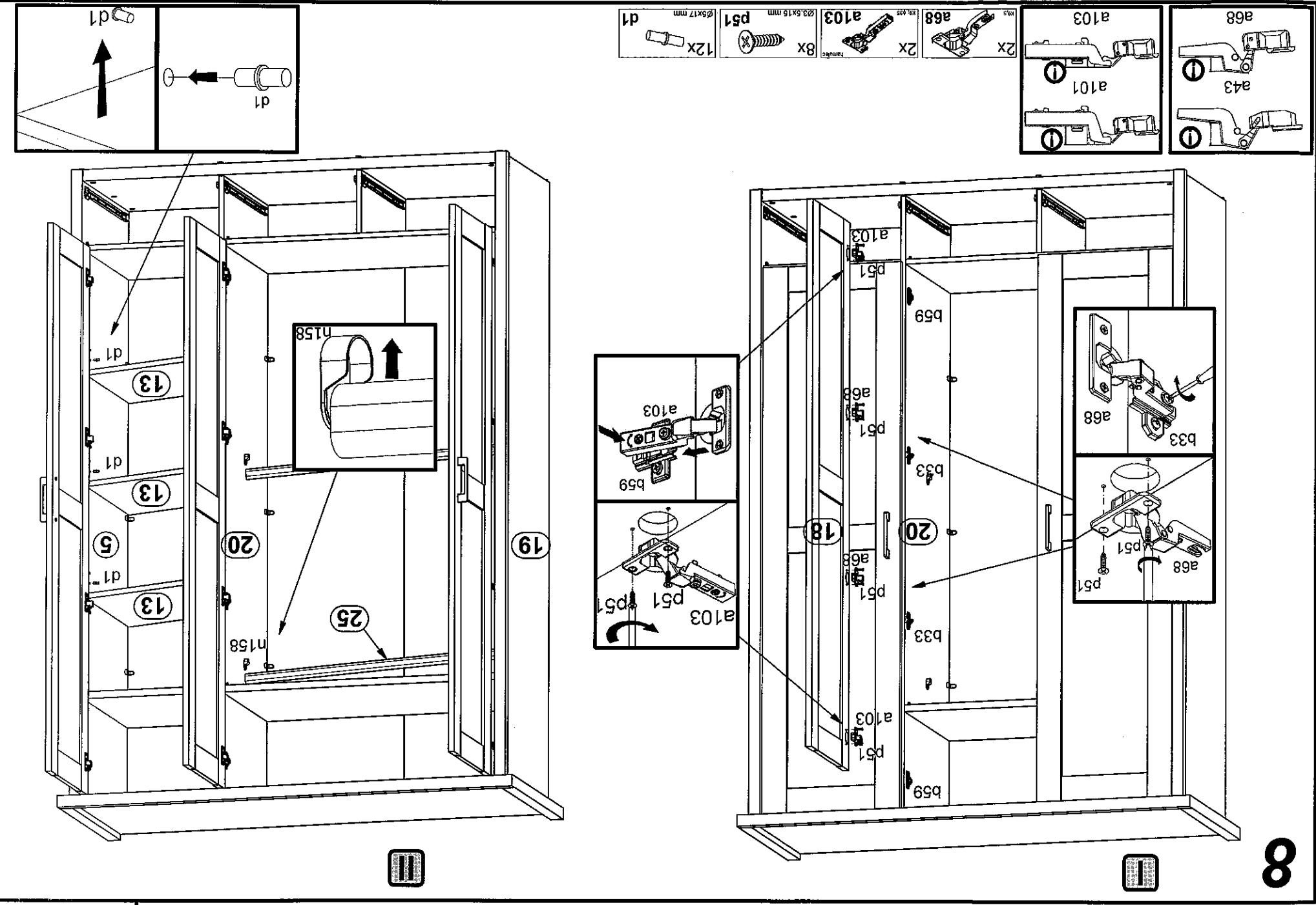

58-059-B5

LUCA BABY

S356-SZF3D3S

9

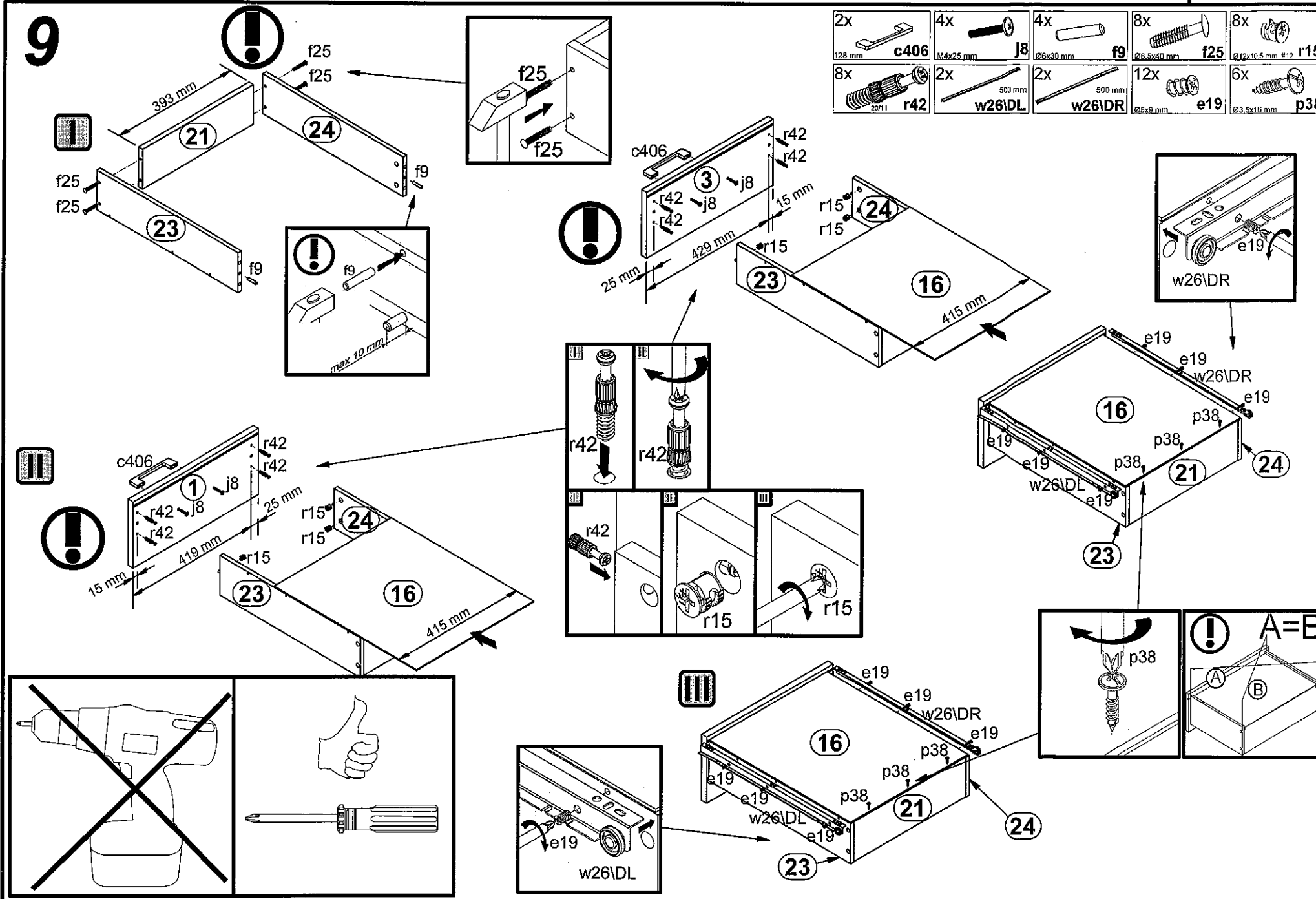

p38 3X	e19 6X	w26DR 500 mm 1X	w26IDL 560 mm 1X	r42 20x11 4X
r15 12x10.5 mm #12 4X	f25 16.5x40 mm 4X	f9 28x30 mm 2X	j8 14x25 mm 2X	c406 128 mm 1X

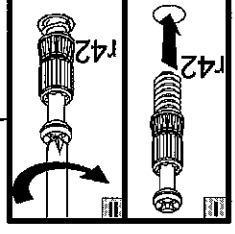
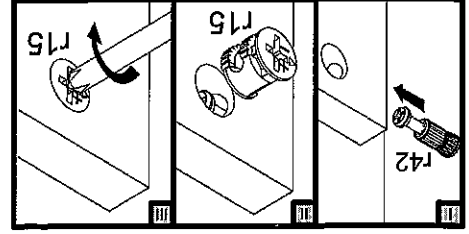
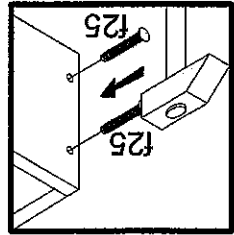
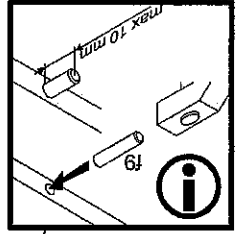
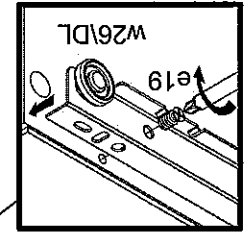
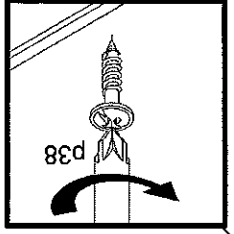
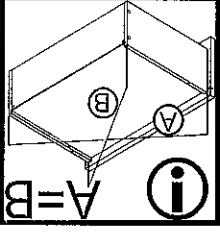
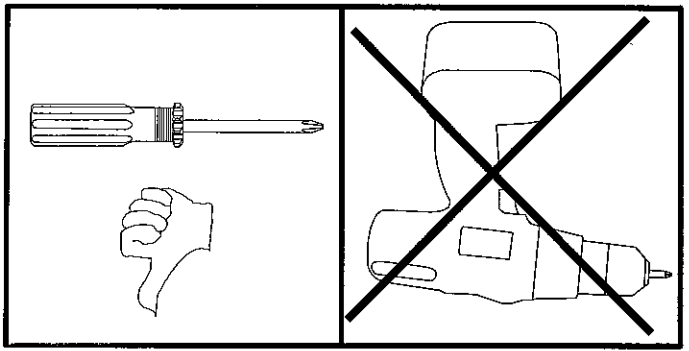
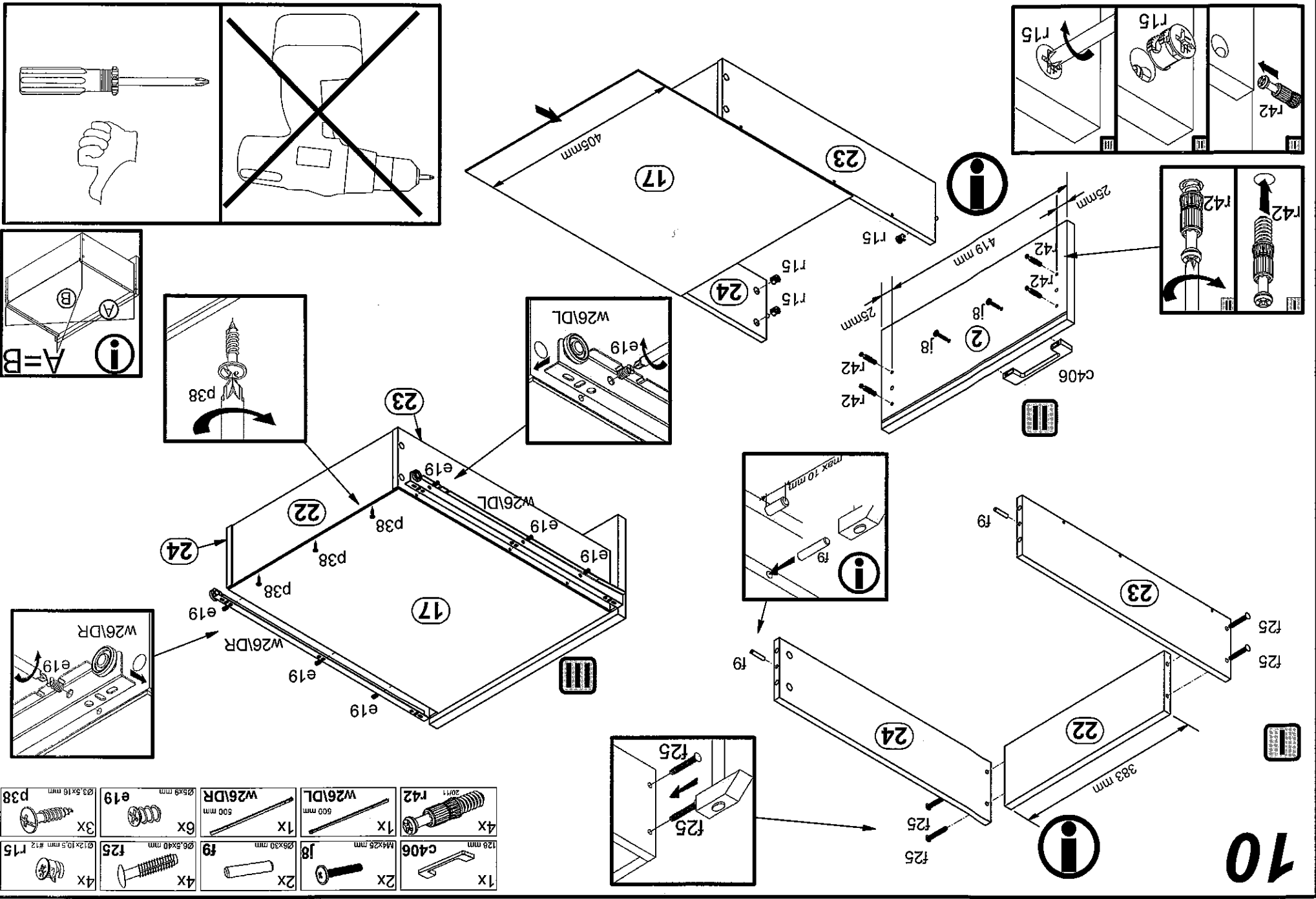

S356-SZF3D3S LUCA BABY 58-059-B5

11

- 2x n1412
- 4x p38
- 2x p17
- 2x f35
- 10x s2

