

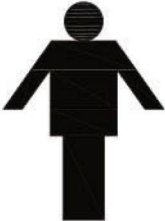

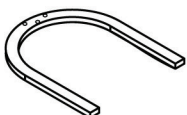

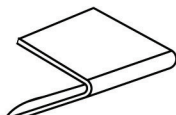



# Amado

|   |   |   |   |  |   |    |   |    |   |
|---|---|---|---|--|---|----|---|----|---|
|  |  |  |  |   |  |    |   |    |   |
|   | A   | 1X  | B   | 1X   | C   | 1X | 1 | 1X | 2 |
|  |  |  |  |  |   |    |   |    |   |
|   | 3   | 4X  | 4   | 1X   | 5   | 1X |   |    |   |

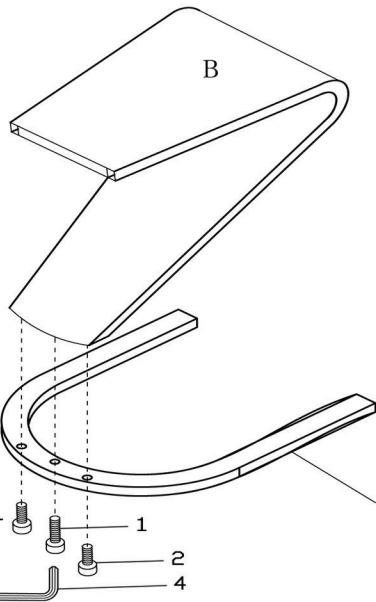
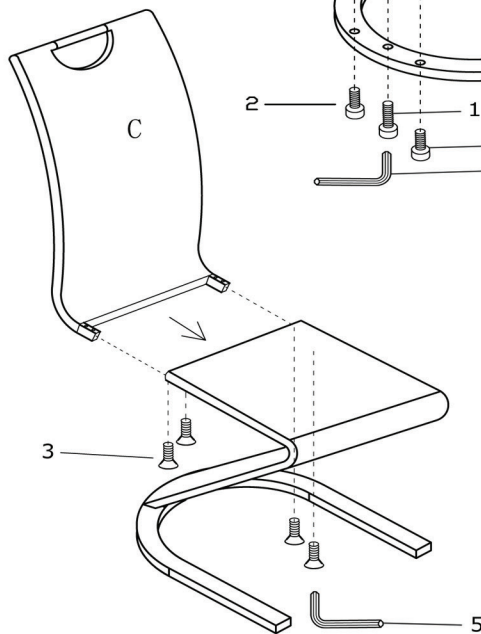
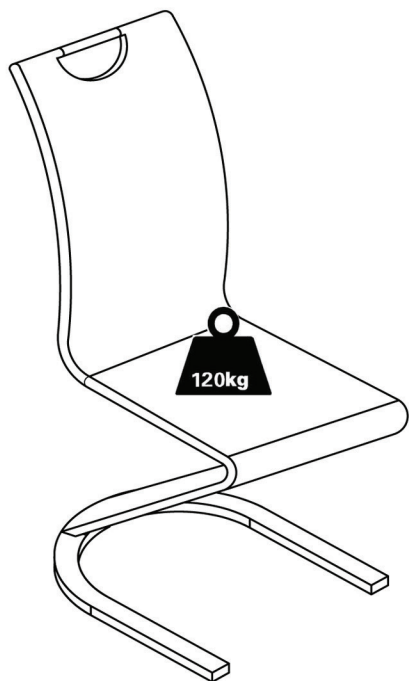

|    |   |     |   |
|----|---|-----|---|
| D  | Bitte überprüfen Sie in regelmäßigen Abständen den festen Sitz der Schrauben! | NL  | Controleer op regelmatige afstanden of de schroeven goed vast zitten. |
| GB | Please check the screws for tightness at regular intervals!                   | SWE | Kontrollera med jämna mellanrum att skruvarna sitter fast ordentligt! |
| F  | Veuillez contrôler régulièrement que les vis sont convenablement serrées !    | SK  | V pravidelných intervaloch kontrolujte pevné dotiahnutie skrutiek!    |
| ES | ¡Compruebe periódicamente que los tornillos estén bien apretados!             | SL  | Redno preverjajte, ali so vijaki trdno priviti!                       |
| IT | Controllare regolarmente che le viti siano ben strette!                       | HR  | Redovito provjeravajte čvrsto nalijeganje vijaka!                     |
| PL | Należy regularnie sprawdzać dokręcenie śrub!                                  |     |   |

MCA

Furniture