

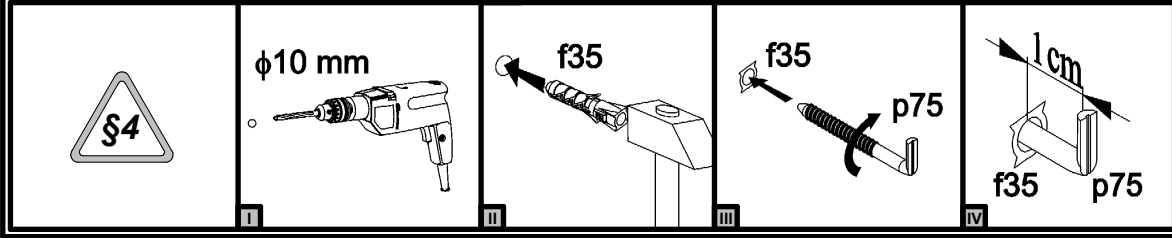

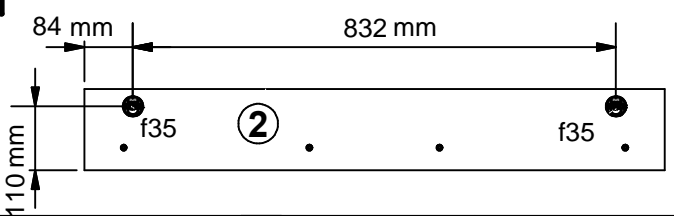

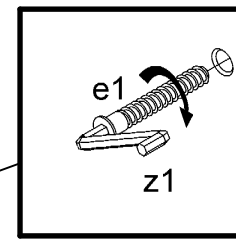
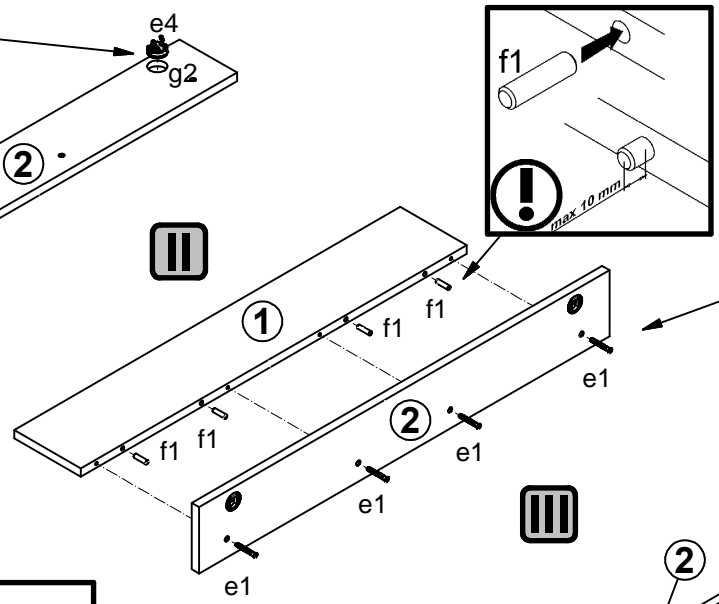
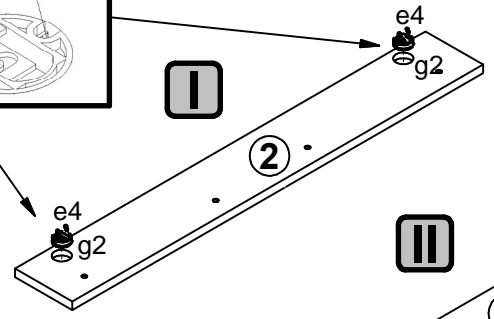
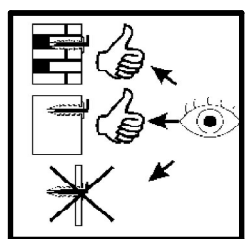
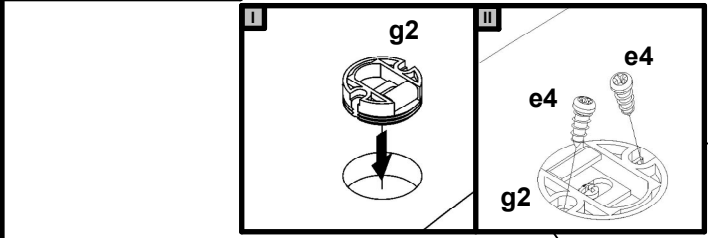
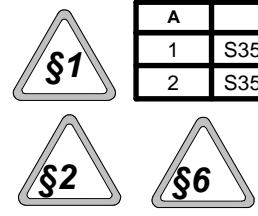
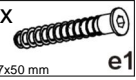

30 min

A	B	C (mm)		D
1	S356-3015	940	162	1/1
2	S356-4001	1000	140	1/1

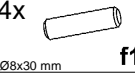

cm

- 4x  e1 (Ø7x50 mm)
- 4x  e4 (Ø5x11 mm)
- 4x  f1 (Ø8x30 mm)
- 2x  f35 (Ø10x50 mm)
- 2x  g2 (Ø5x50 mm)
- 2x  p75 (Ø6x60 mm)
- 1x  z1 (4 mm)

