

4x a43	4x b19	6x c406 128 mm	16x d1 Ø5x17 mm	24x e3 Ø9x13 mm	16x e19 Ø5x9 mm	4x e22 Ø7x28 mm	16x f1 Ø8x30 mm	8x f9 Ø6x30 mm	16x f25 Ø8.5x40 mm	12x j8 M4x25 mm	6x k1	2x k3912 Ø6.5x14x14 mm
2x k3913 M8/22 mm	12x l2	12x p38 Ø3.5x16 mm	8x p51 Ø3.5x15 mm	16x r1 Ø15x12 mm #16	16x r15 Ø12x10.5 mm #12	32x r42	8x s2 Ø16	4x w45ICL 350 mm	4x w45ICR 350 mm	4x w45IDL 350 mm	4x w45IDR 350 mm	1x z1
1x n2611	1x p38 Ø3.5x16 mm											

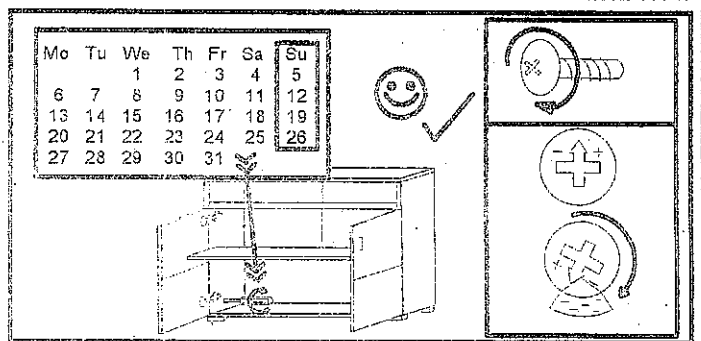

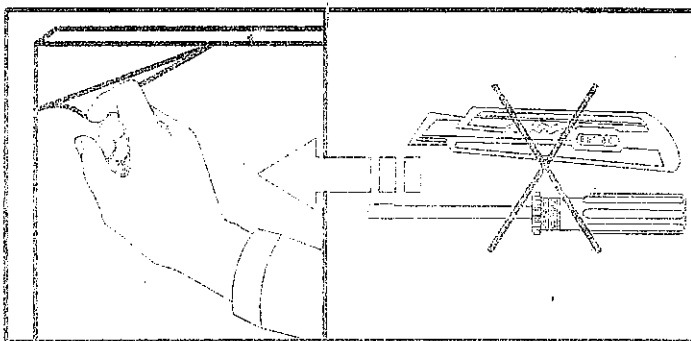

2

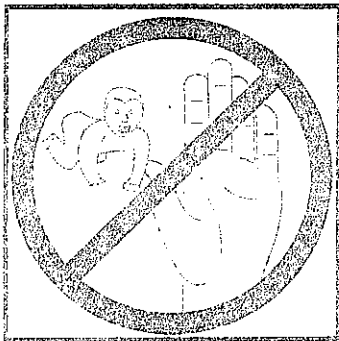
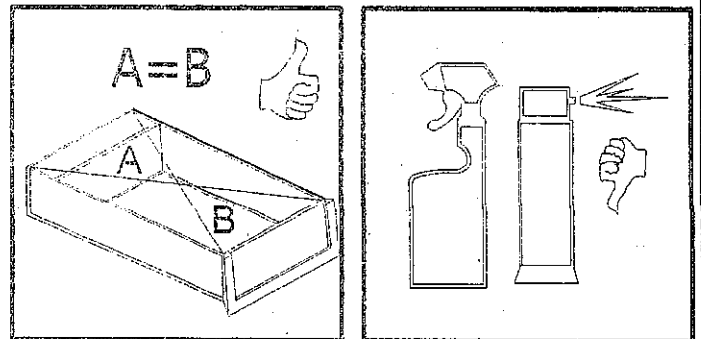
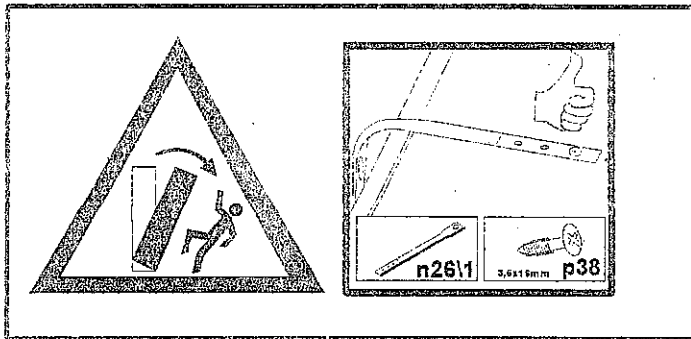
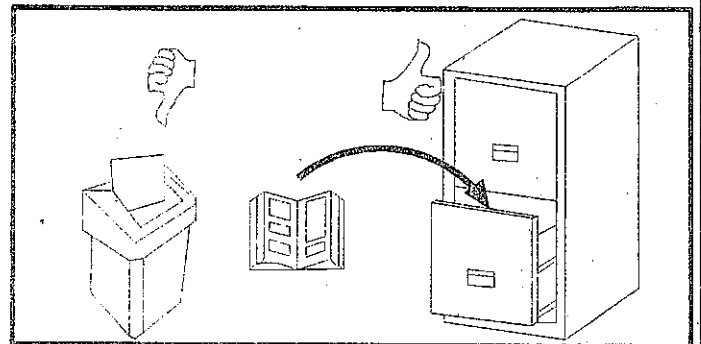
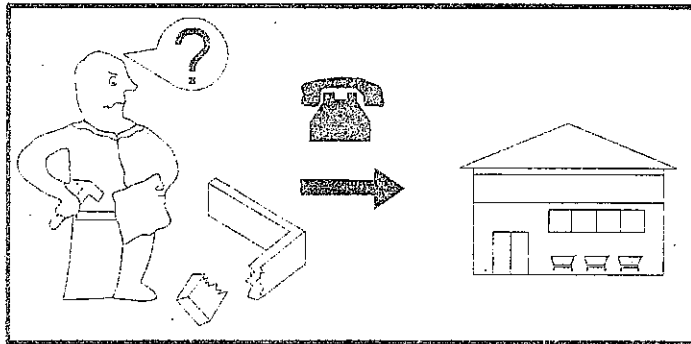
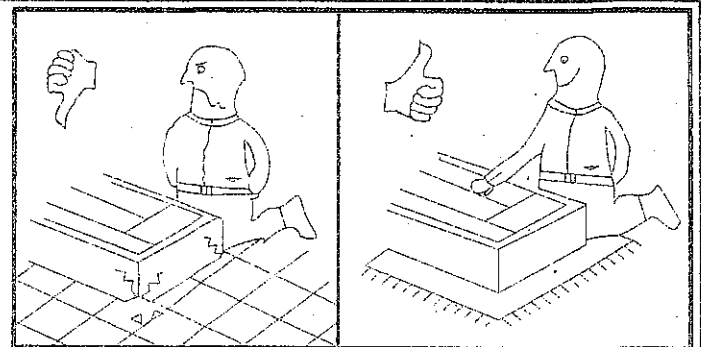
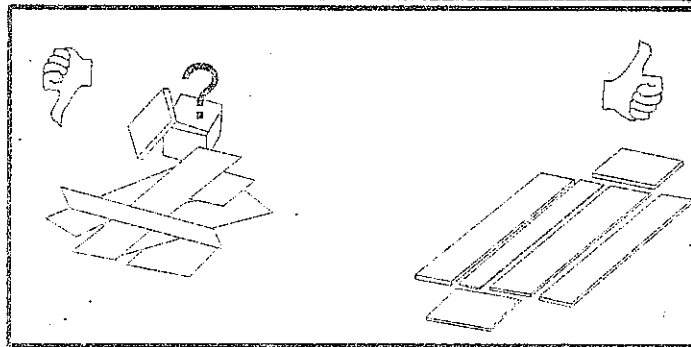
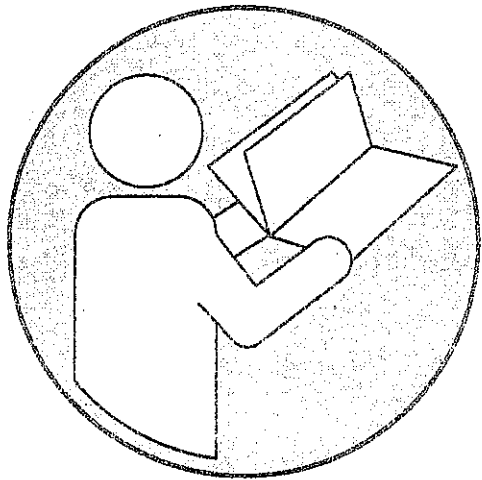
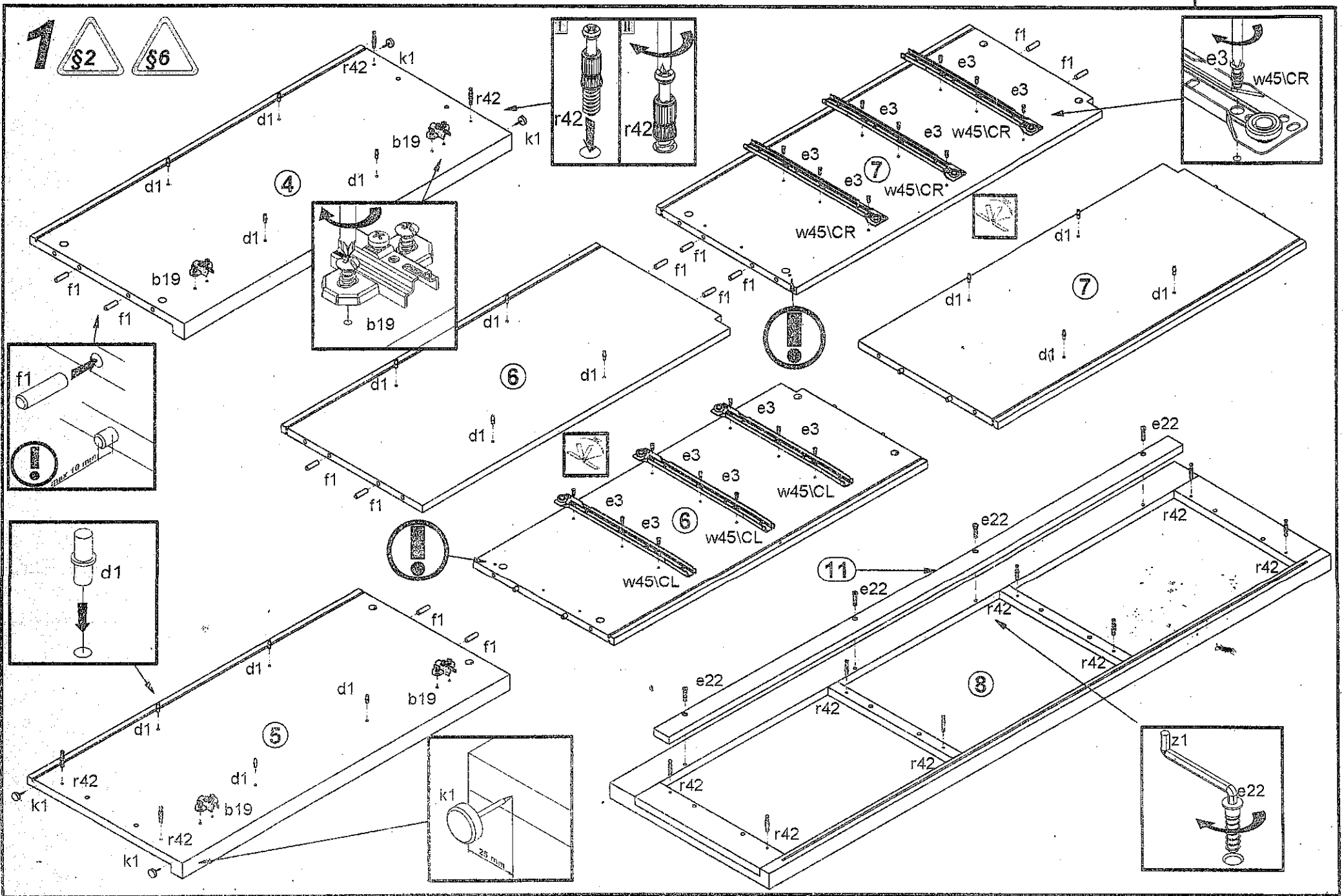
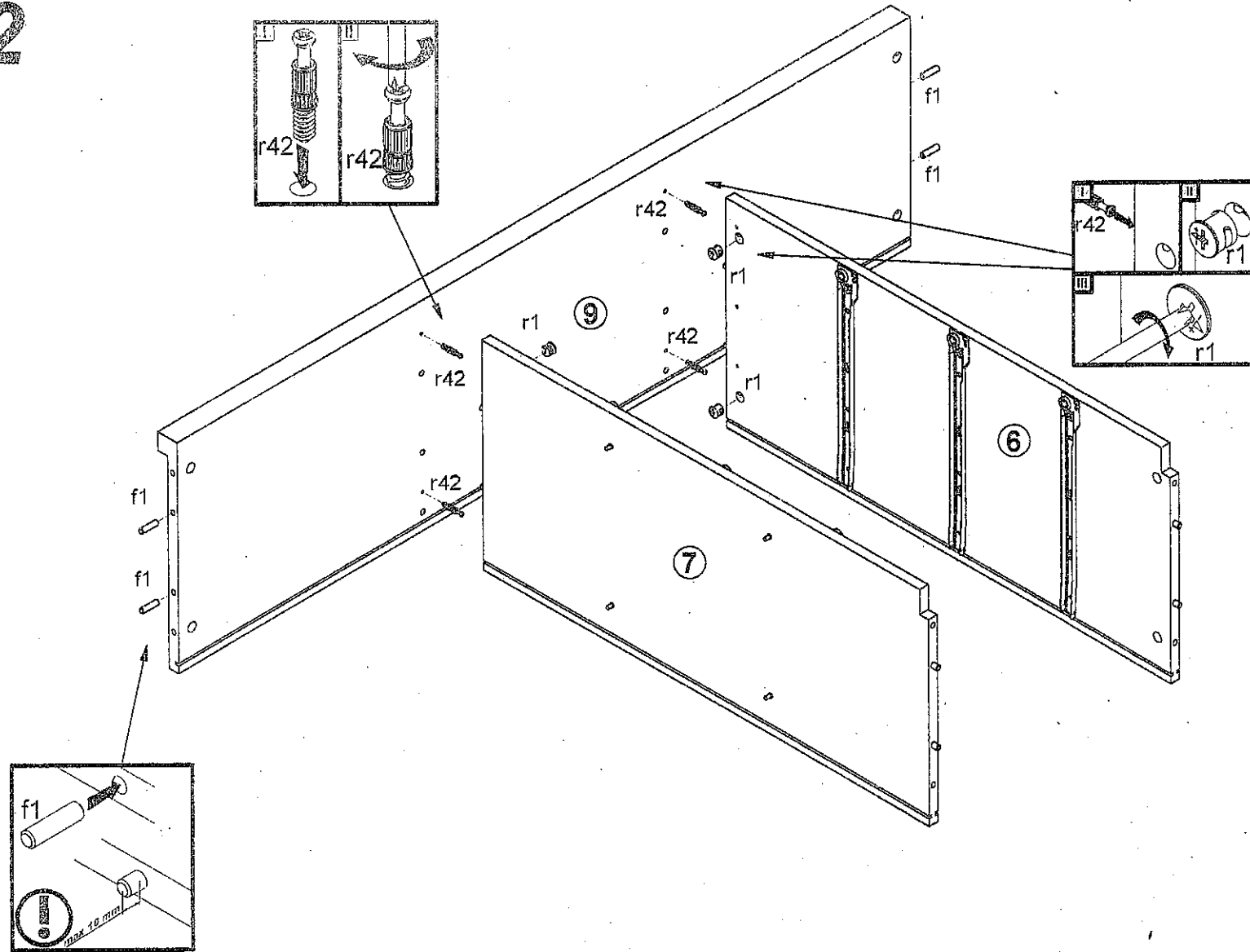

3

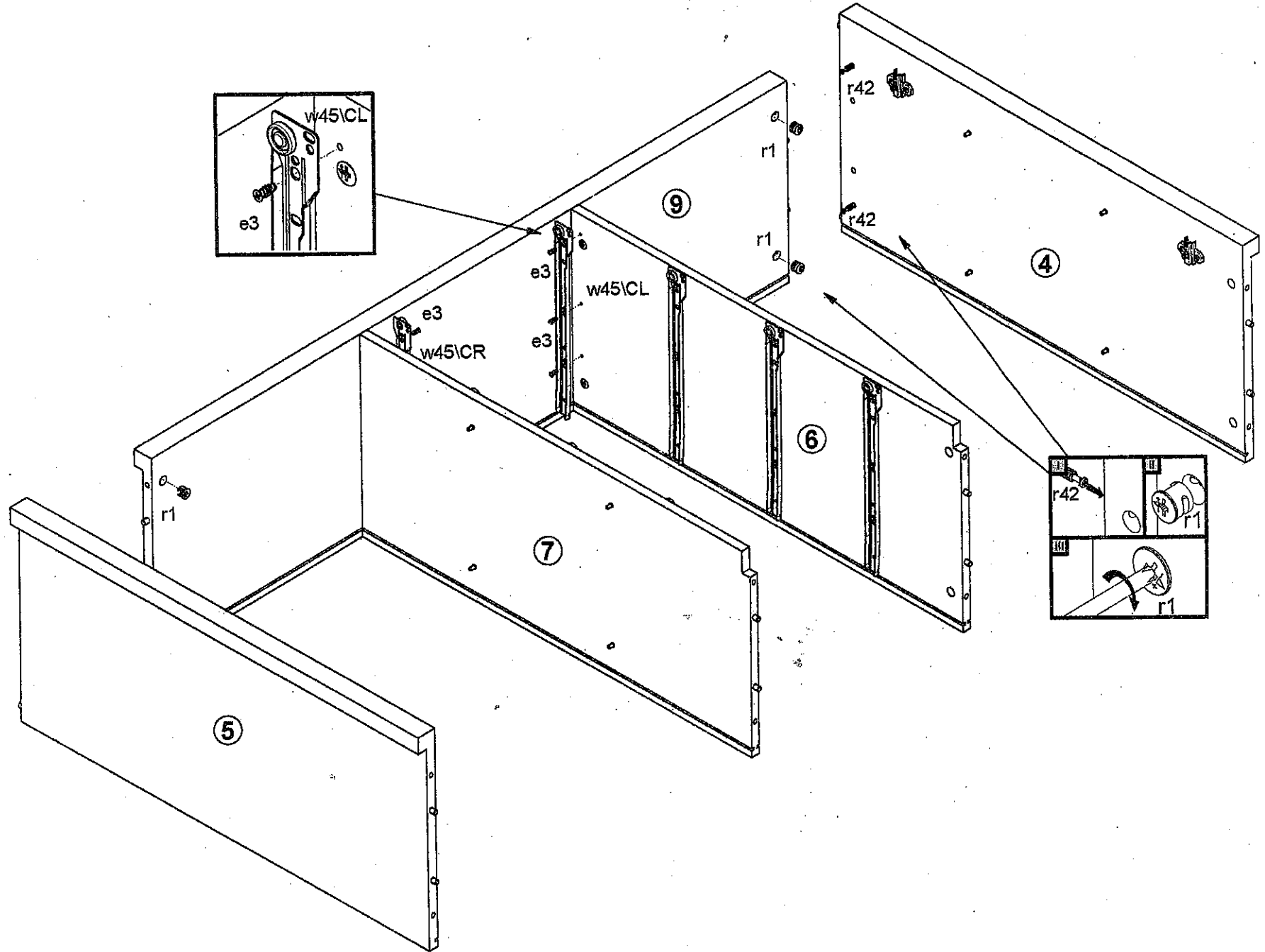

4

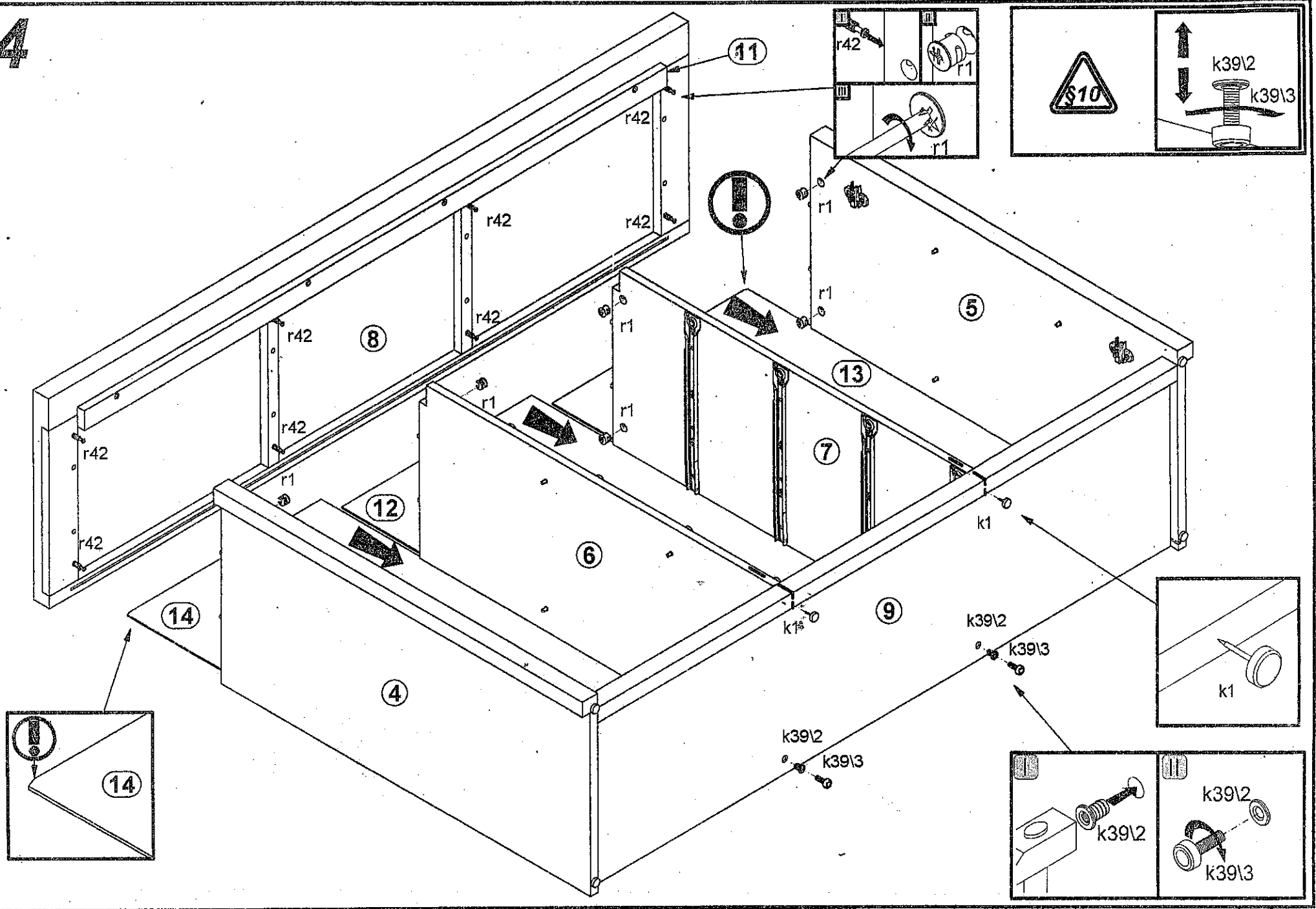

5

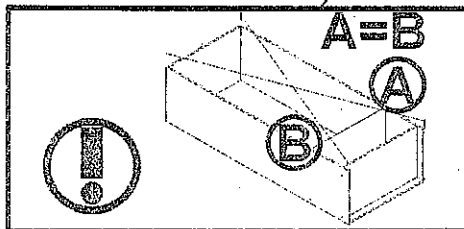
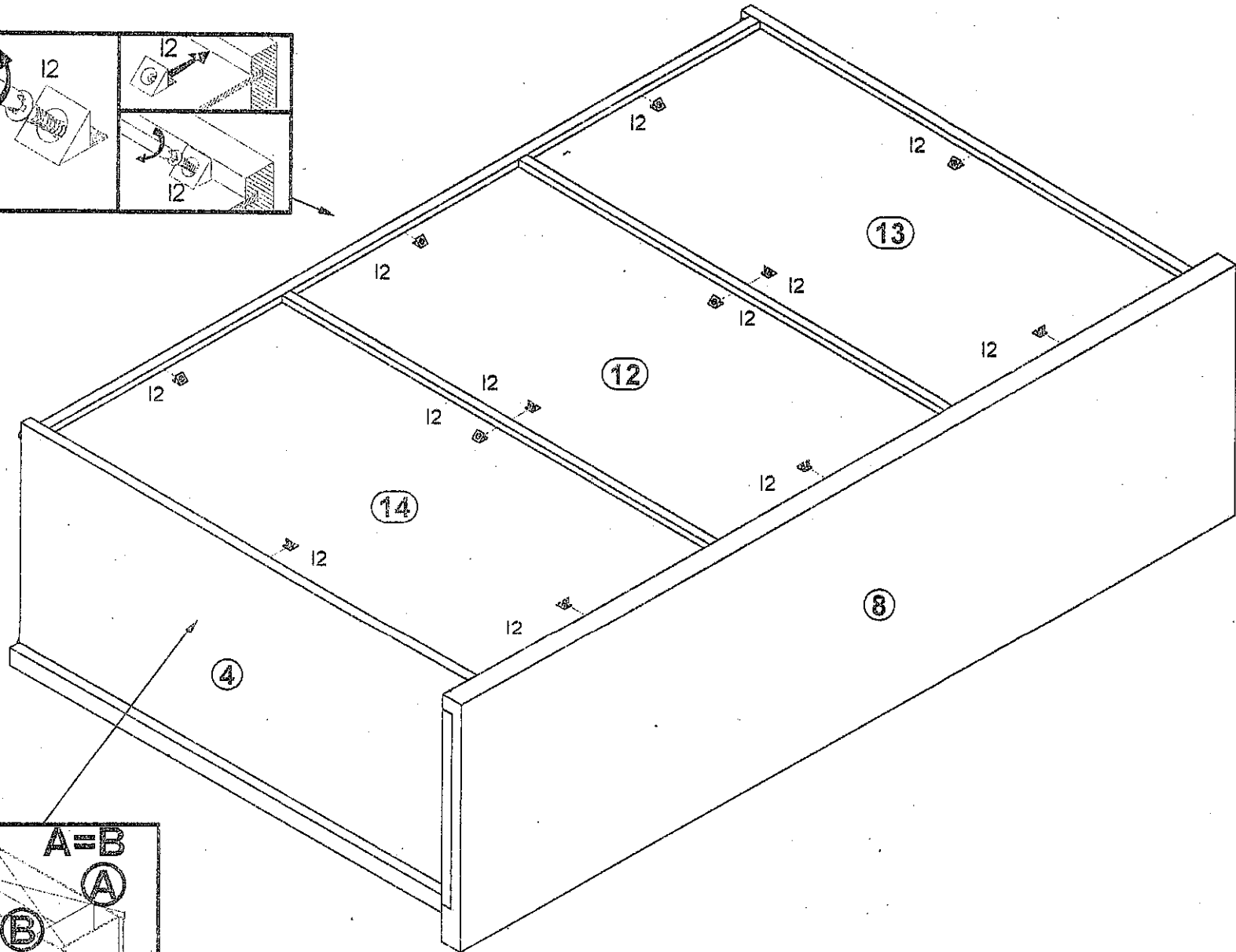
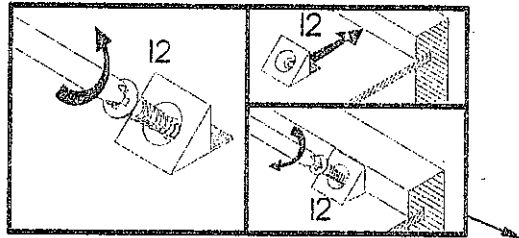

6

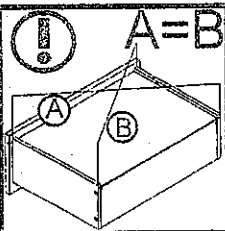
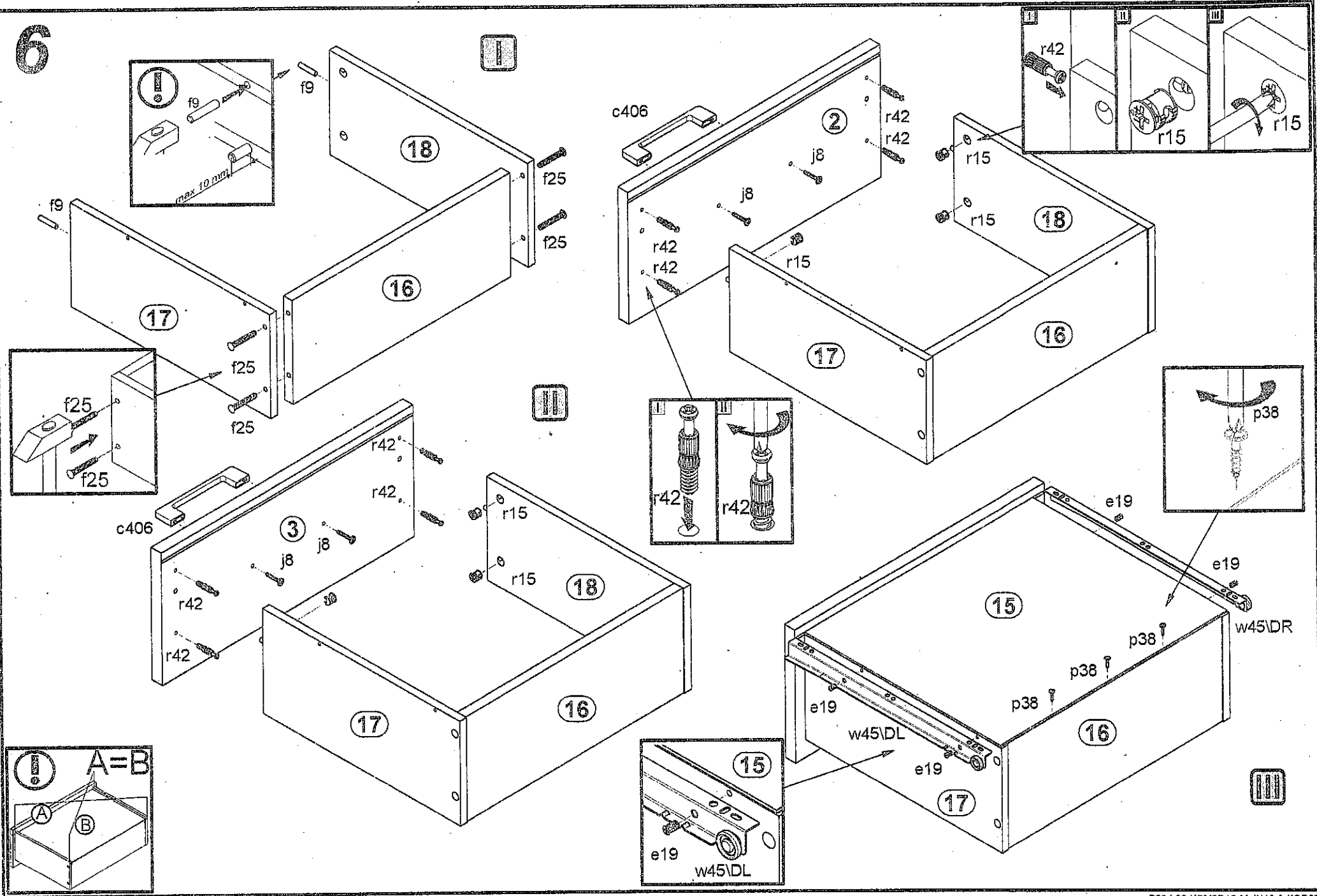

7

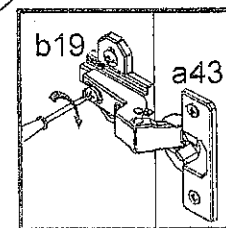
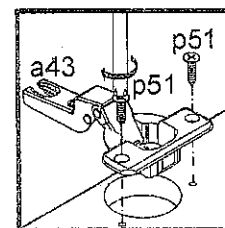
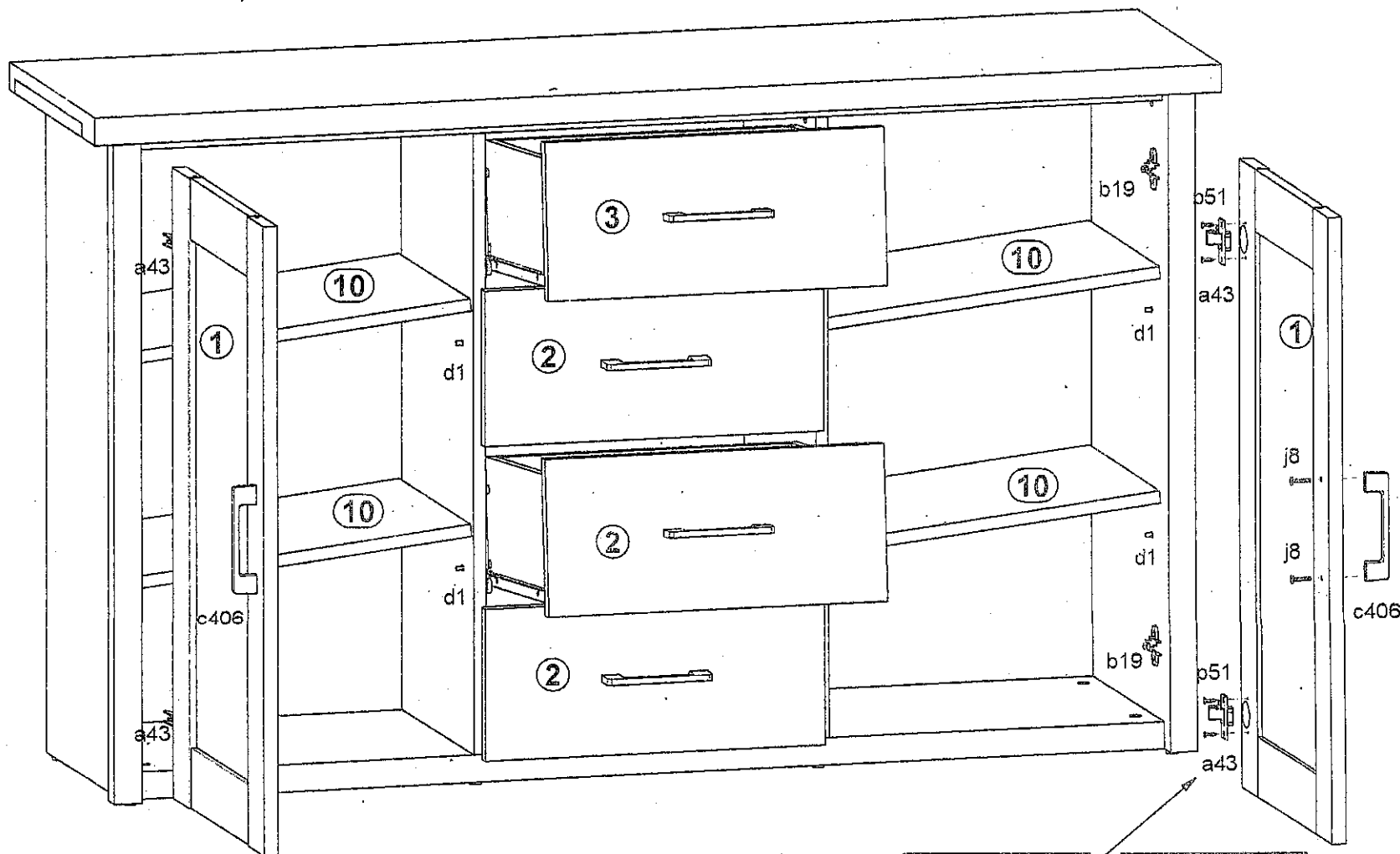
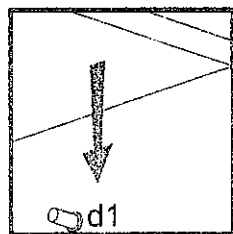

8

