

980753

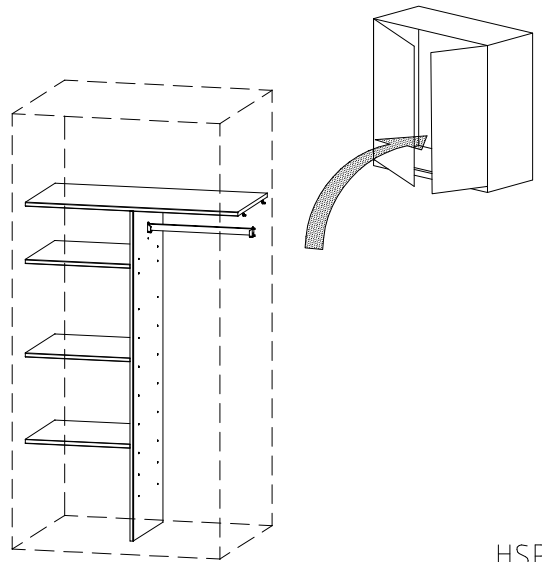

HSP

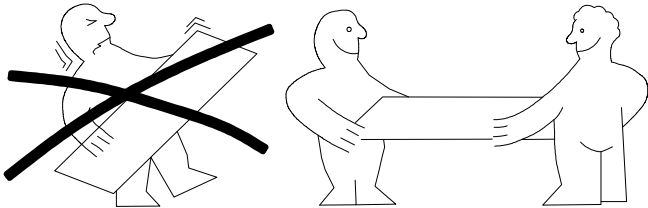
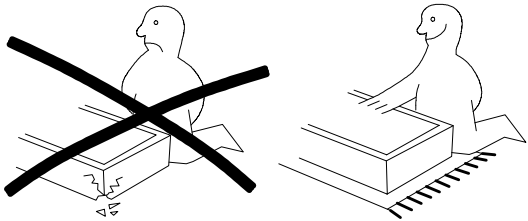
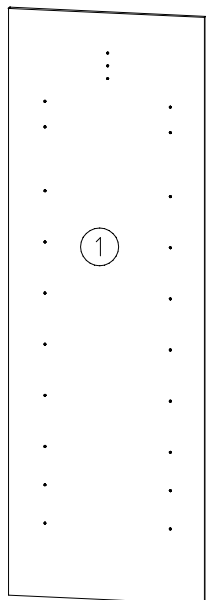
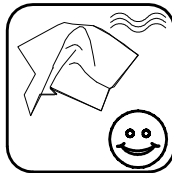
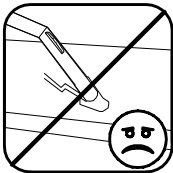
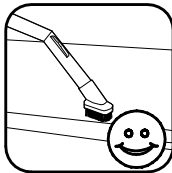
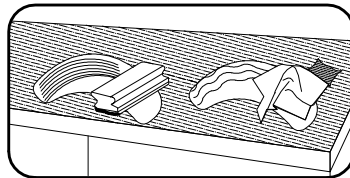
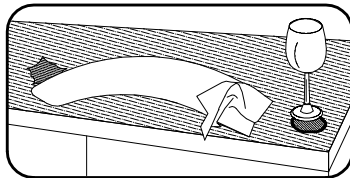
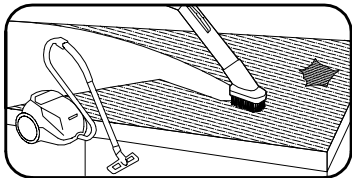
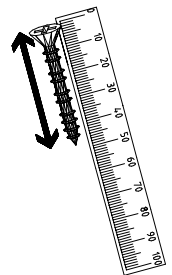
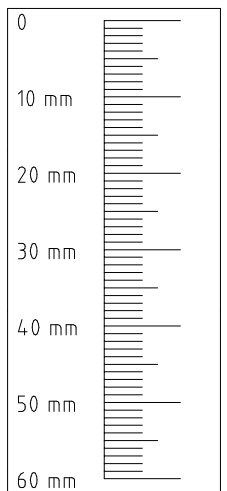
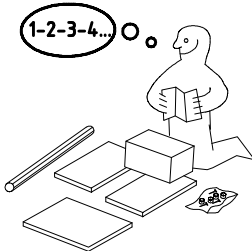
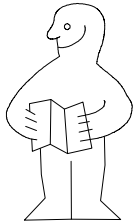

1469x500x15

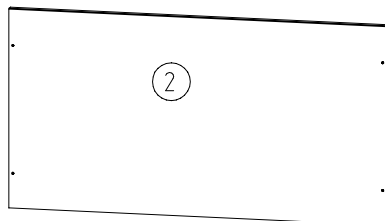



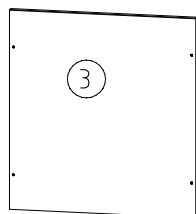

964 x 500 x 18

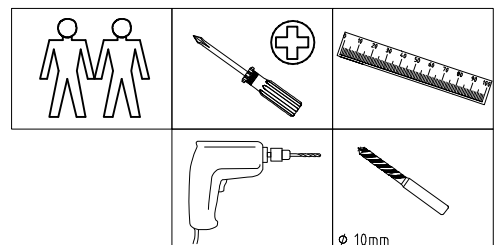

3x 475 x 500 x 18

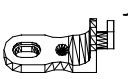
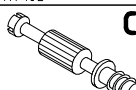

 111 102	<b>A</b> 2x	 111 610	<b>L7</b> 16x	 111 174	<b>J1</b> 1x
 111 103	<b>C</b> 2x	 112 401	<b>K11</b> 1x	 121 120	<b>SP14</b> 4 X 15mm 1x

980753

06.12.16 / -

12 16

1/4

1

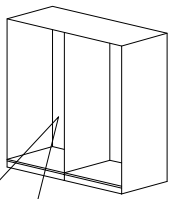

K10  
100cm  
112 400

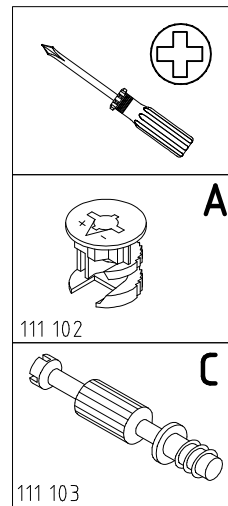
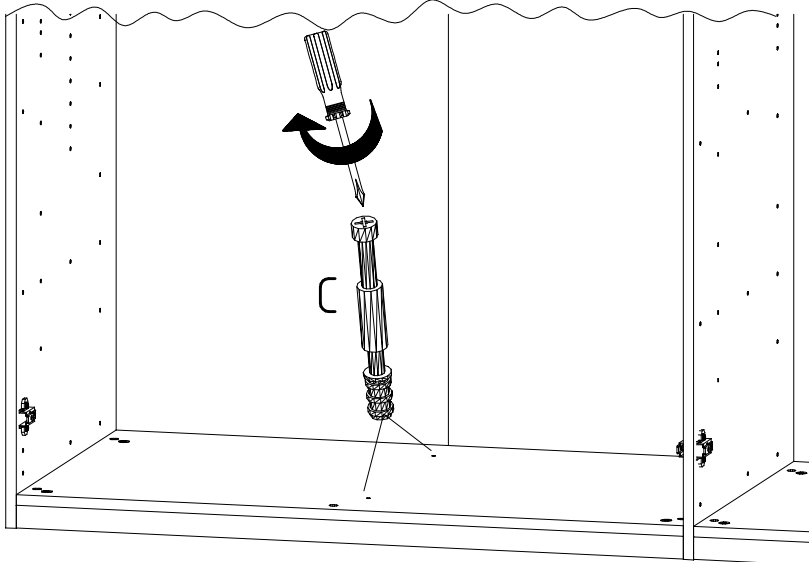
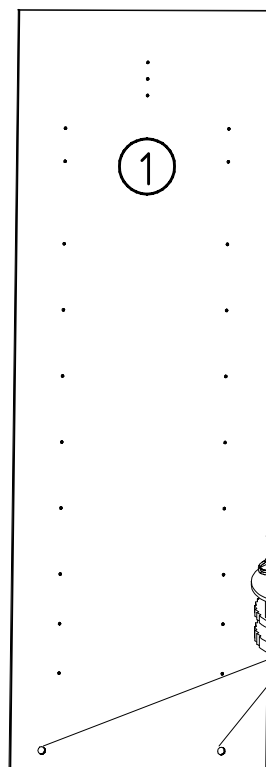
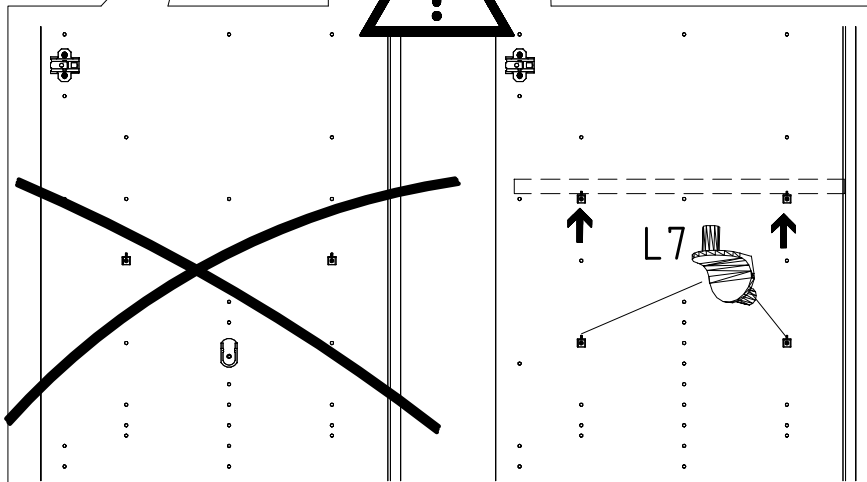

2

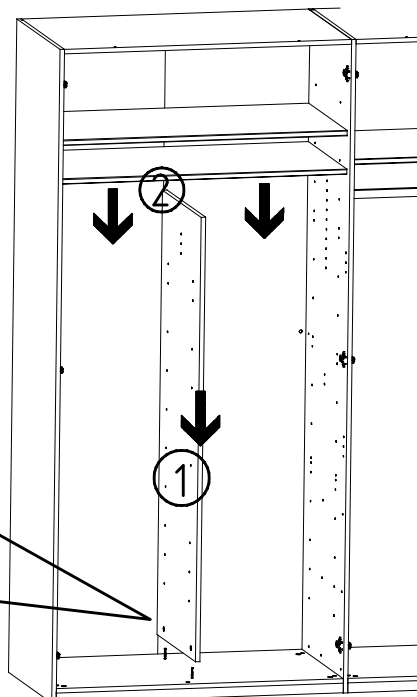
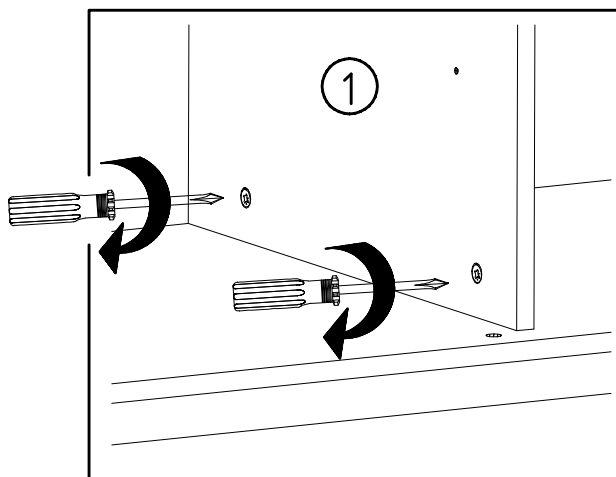
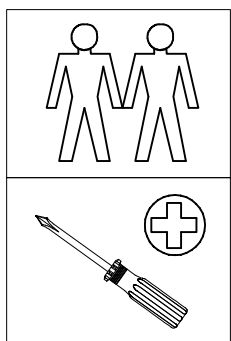

3

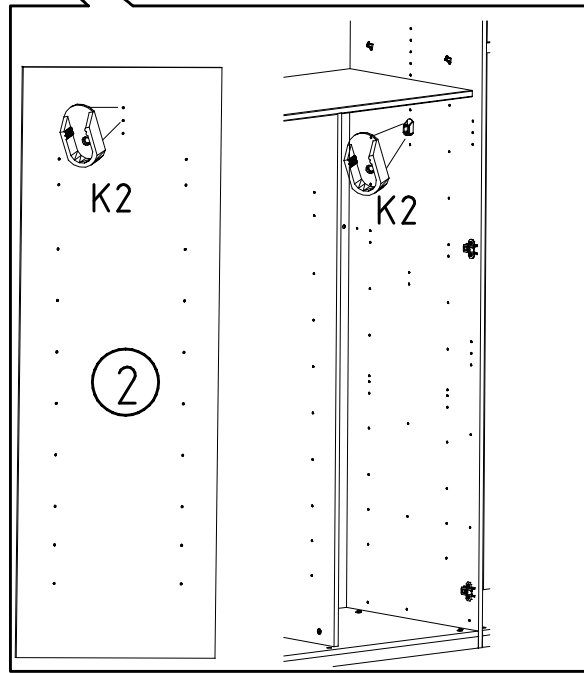
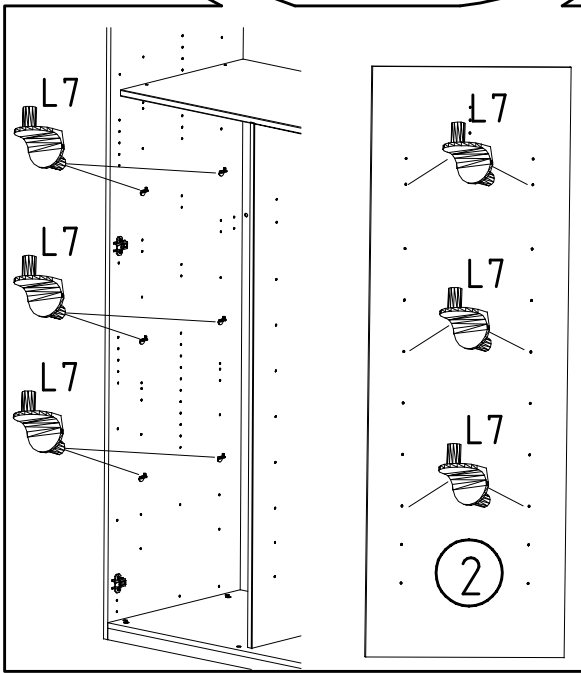
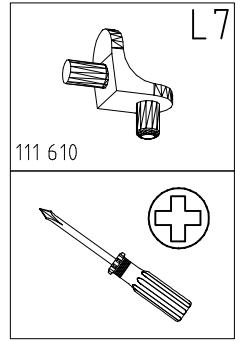
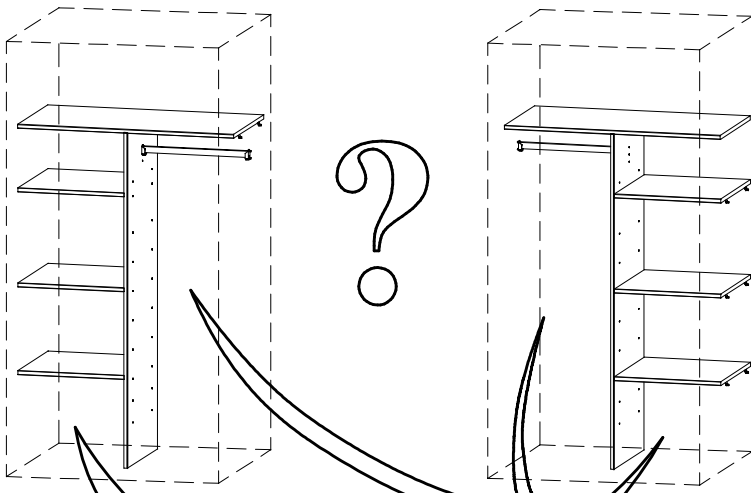

4

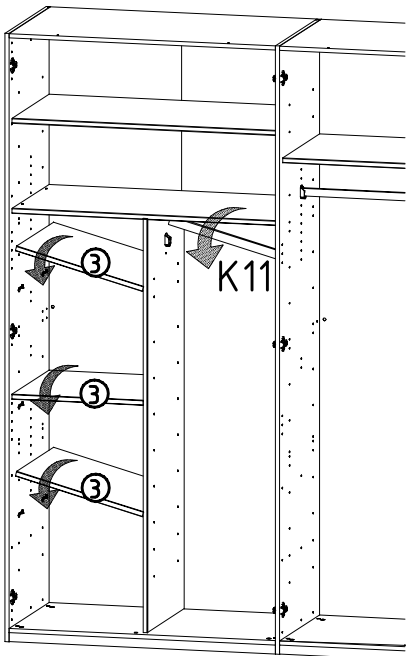
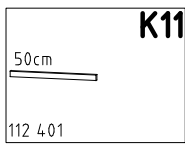

5

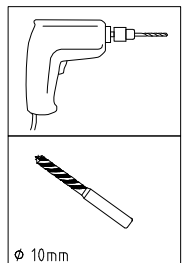
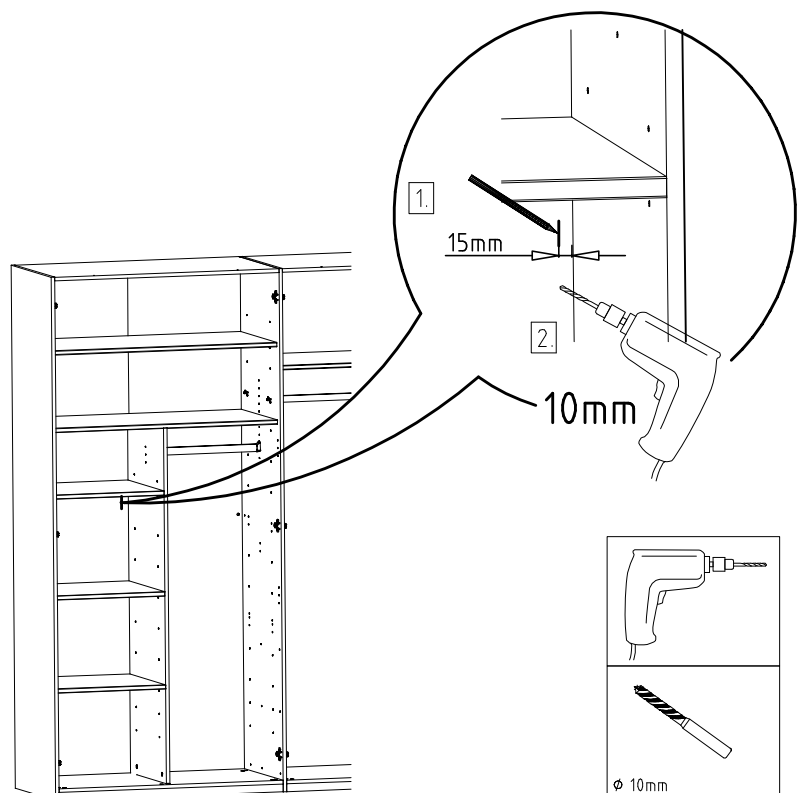

980753

06.12.16 / -

12 16

3/4

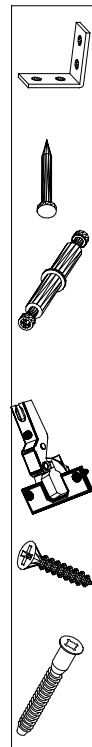
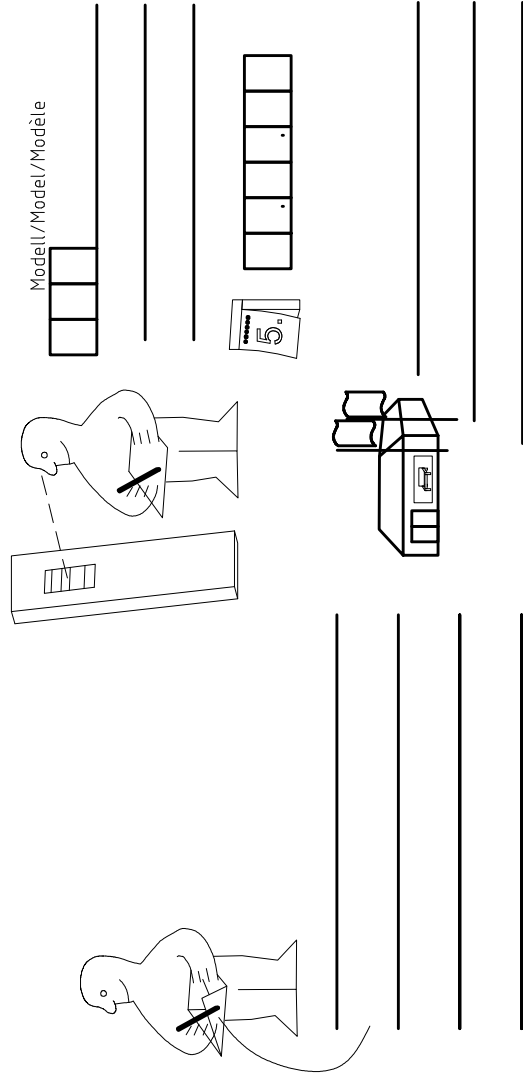
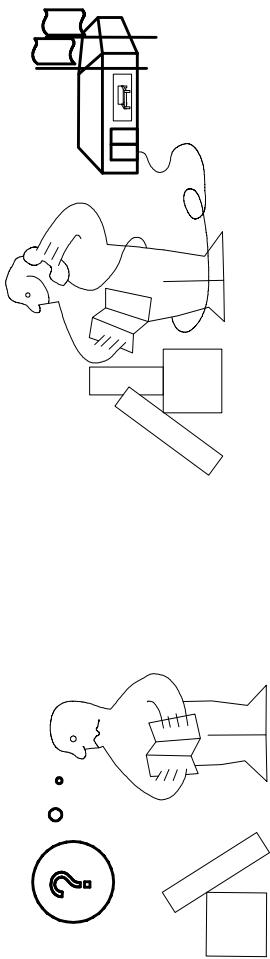
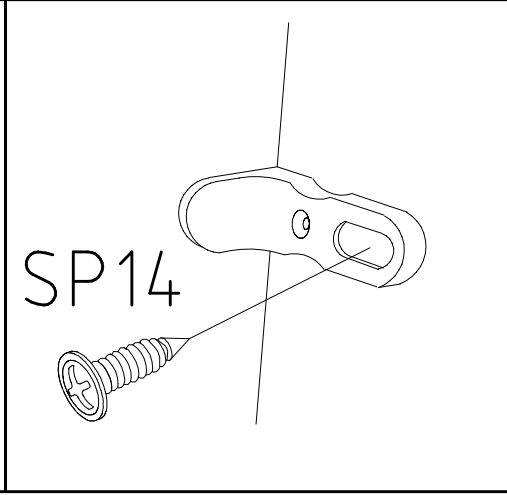
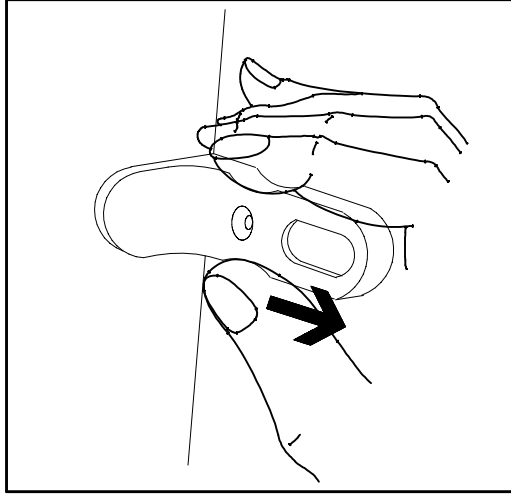
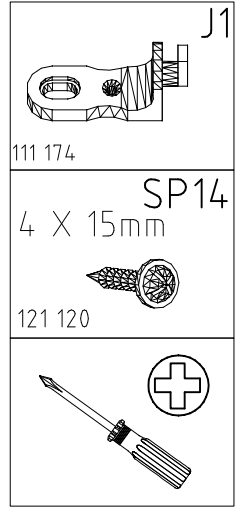
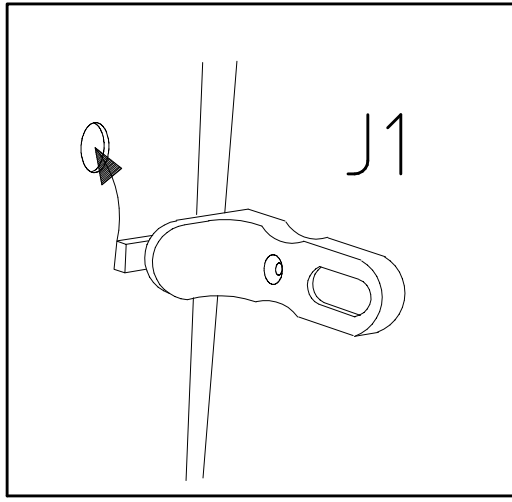

(121 370)	( G 1 )	(4x)

Änderungen die dem technischen Fortschritt geschuldet sind, behalten wir uns vor!  
Bei nicht vorschriftsmäßiger und/ oder nicht fachmännischer Montage wird bei Personen- und/ oder Sachschäden keine Haftung übernommen.