

Type: **110**

Blatt Nr **1** von: **6**

- ① Platte
- ② Streifen lange
- ③ Streifen kurz
- ④ Fuß L teil R
- ⑤ Fuß R teil L
- ⑥ Fuß R teil R
- ⑦ Fuß L teil L
- ⑧ E-Boden

max.



①

max.



⑧

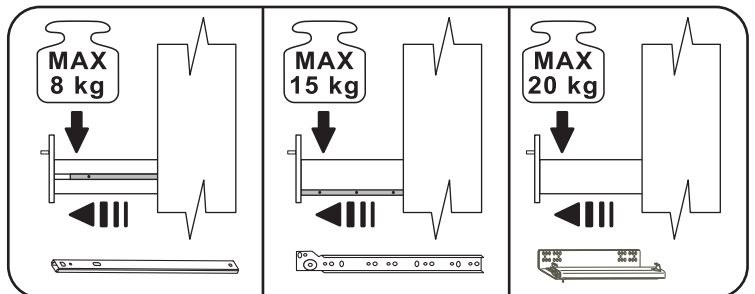
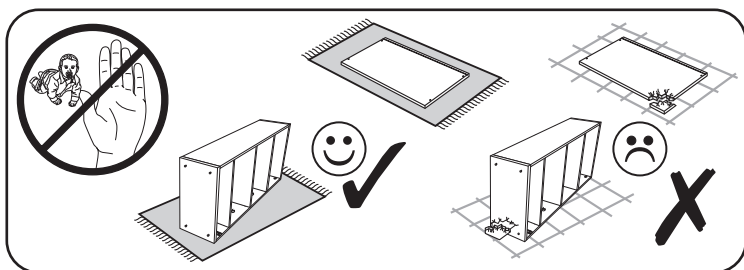
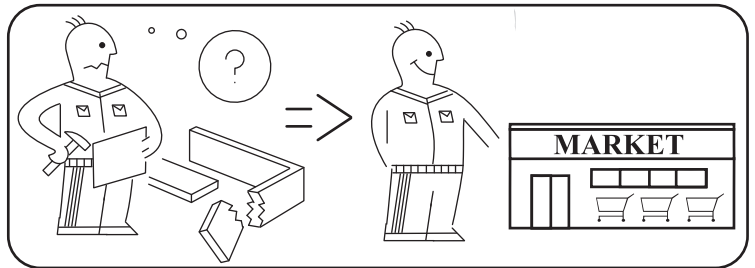
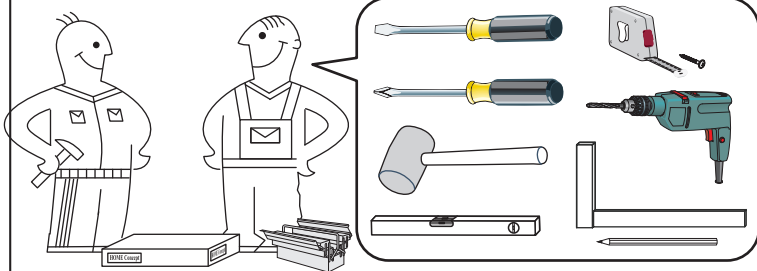
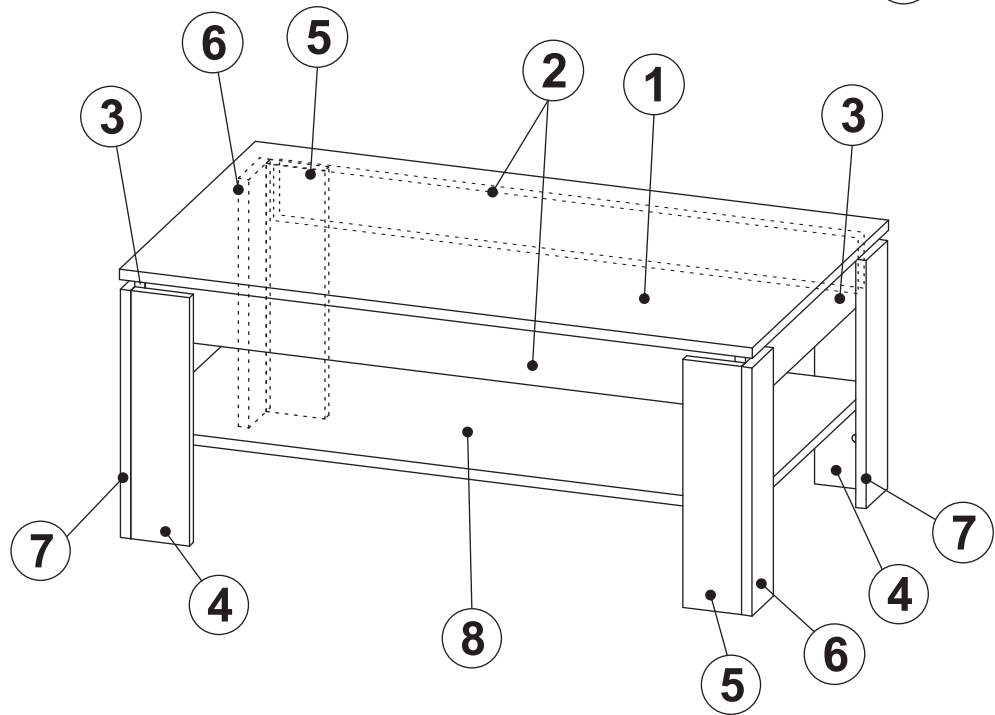

Type: **110**



Blatt Nr **2** von: **6**

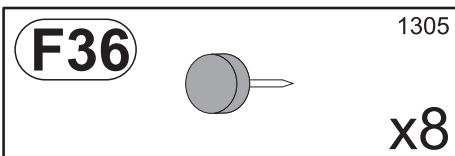
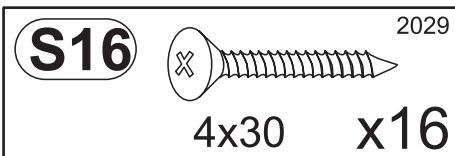
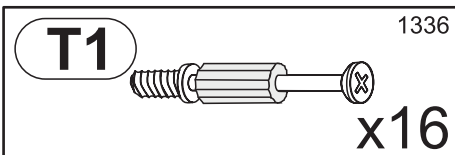
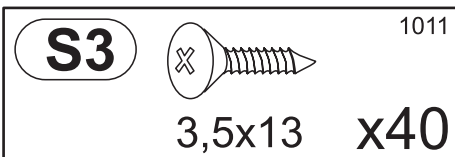
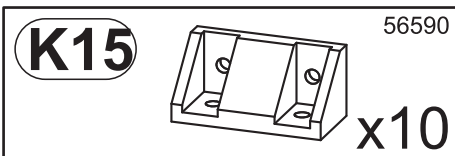
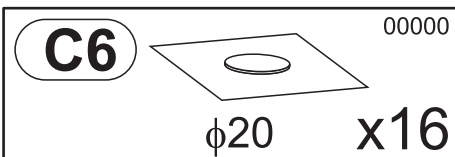
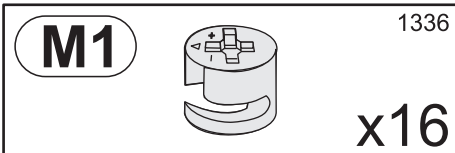
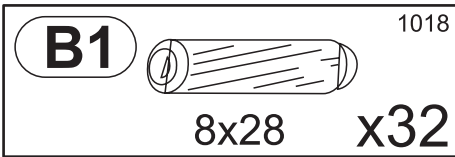

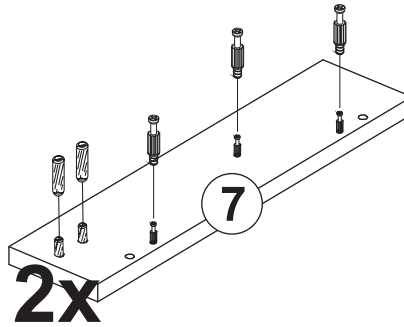
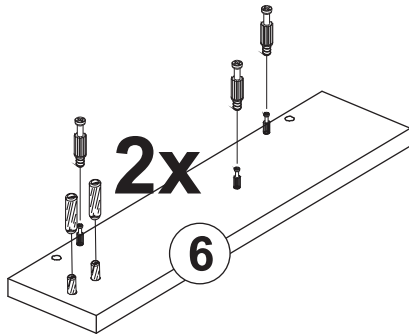
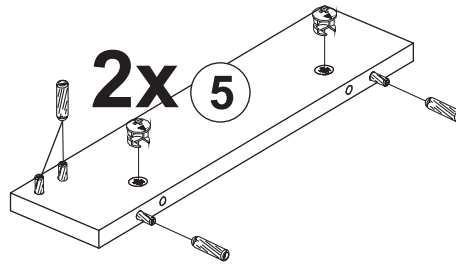
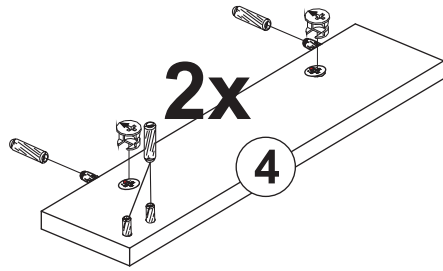

<b>B1</b>		1018
	8x28	x32
<b>M1</b>		1336
		x12
<b>K15</b>		56590
		x10
<b>S3</b>		1011
	3,5x13	x20
<b>T1</b>		1336
		x16

